

+GF+

See the Difference

SeaDrain® White 2022 Technical Product Guide



See the difference above and below the line



Increased safety onboard

SeaDrain White is produced from a light, flexible, tough and corrosion-free high-performance polymer. To reduce the risk of bacterial contamination of the ship, factory tests in excess of 100 psi (6 bar) have been conducted.



Environmentally friendly

Made of polypropylene plastic, SeaDrain White takes less CO₂ to manufacture making it an eco-friendly alternative to metals.

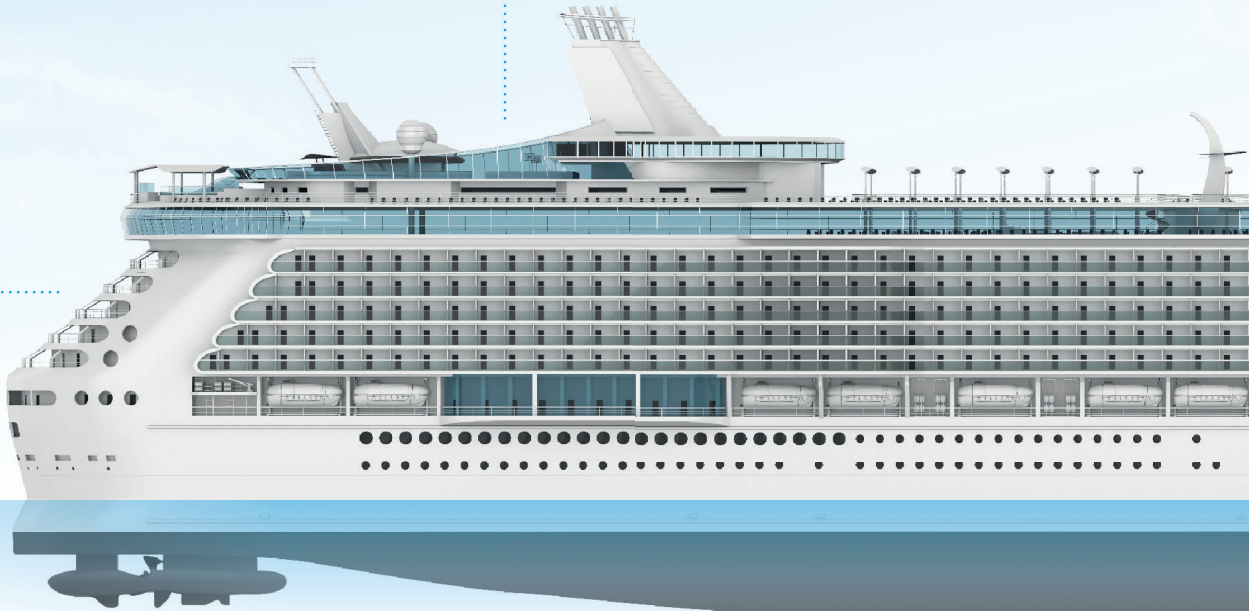

UV-resistant, no paint needed

SeaDrain White's bright white external coloring includes additives for UV resistance against discoloration, negating the need for external paint. This results in both pleasing aesthetics and reduced work hours across an install of up to 24,000 ft. of balcony piping alone.



Lower operating costs

Made entirely from a non-corroding thermoplastic, SeaDrain White is engineered for a minimum of 25 years life compared to 5 to 10 years for metal alternatives.

50%

weight savings versus metal systems

4 Bar

best in class safety pressure rating



A complete piping system for black and gray water drainage on passenger vessels, SeaDrain® White offers a lightweight, easy-to-install system that enhances safety and efficiency on board. The corrosion-free and incrustation-free plastic piping system effectively eliminates leakage and downtime due to corrosion damage.



Less downtime

The ultra-smooth inner surface of SeaDrain White eliminates encrustation and reduces downtime.



Fast installation

The unique push-fit and lock mechanism of the SeaDrain Fast-Lock® jointing system makes installation up to 5x faster than alternative metal solutions.

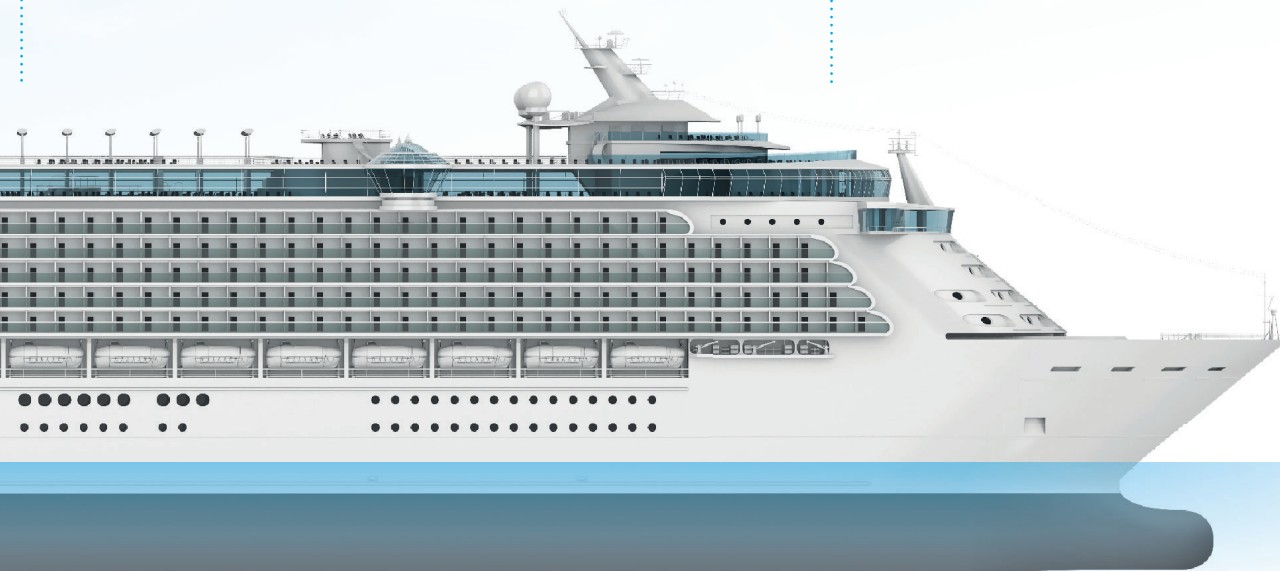

Easy to install

With a single tool, SeaDrain Fast-Lock is quick and easy to install for line sizes 4" (DN100) and below. Automated electrofusion is available in all sizes 1½" (DN40) to 6" (DN150).



Multiple jointing options

With multiple jointing options, SeaDrain White makes it easy to transition between food prep (USPH) and general use application spaces.

45,000

fewer pipe hangers*

\$930k

average install saving*

*Based on vessel size of 130,000 GT

SeaDrain® White Technical data

Material

- Color: bright white
- Schedule 40 PPFR
- Up to 10-year UV protection
- Laser print stream (non-color)

Size range and fusion types

- 1½" IPS (DN40) – Electrofusion / Fast-Lock
- 2" IPS (DN50) – Electrofusion / Fast-Lock
- 2½" IPS (DN65) – Electrofusion / Fast-Lock
- 3" IPS (DN80) – Electrofusion / Fast-Lock
- 4" IPS (DN100) – Electrofusion / Fast-Lock
- 6" IPS (DN150) – Electrofusion

Temperature rating

- Constant temperature: 180°F (82°C)
- Intermittent temperature: 212°F (100°C)

Pressure / Vacuum rating

- Standard Operating: 14.5psi (1.0 bar)
- Long-Term Burst: 36 psi (2.5 bar)
- Short-Term Burst: 58 psi (4.0 bar)
- Vacuum: -29 psi (-2.0 bar)

Standards

- ASTM D635 (HB)
- ASTM F1412
- USPH (with electrofusion jointing)

Weight comparison

Size	Stainless steel black and gray water		SeaDrain White	
	lb / ft	kg / m	lb / ft	kg / m
1½" IPS (DN40)	0.8	1.3	0.3	0.5
2" IPS (DN50)	1.1	1.6	0.4	0.7
2½" IPS (DN65)	1.3	1.9	0.7	1.0
3" IPS (DN80)	1.4	2.2	0.9	1.4
4" IPS (DN100)	1.9	2.9	1.3	1.9
6" IPS (DN150)	3.7	5.5	2.3	3.4

Maximum horizontal support hanger comparison

Size	Other plastic black and gray water		SeaDrain White	
	(ft)	(m)	(ft)	(m)
1½" IPS (DN40)	1.6	0.5	6.6	2.0
2" IPS (DN50)	2.1	0.6	8.2	2.5
2½" IPS (DN65)	2.5	0.8	9.8	3.0
3" IPS (DN80)	3	0.9	9.8	3.0
4" IPS (DN100)	3.6	1.1	9.8	3.0
6" IPS (DN150)	5.2	1.6	9.8	3.0

Approvals



Option 1: Jointing by electrofusion

Option 2: Fast-lock mechanical jointing

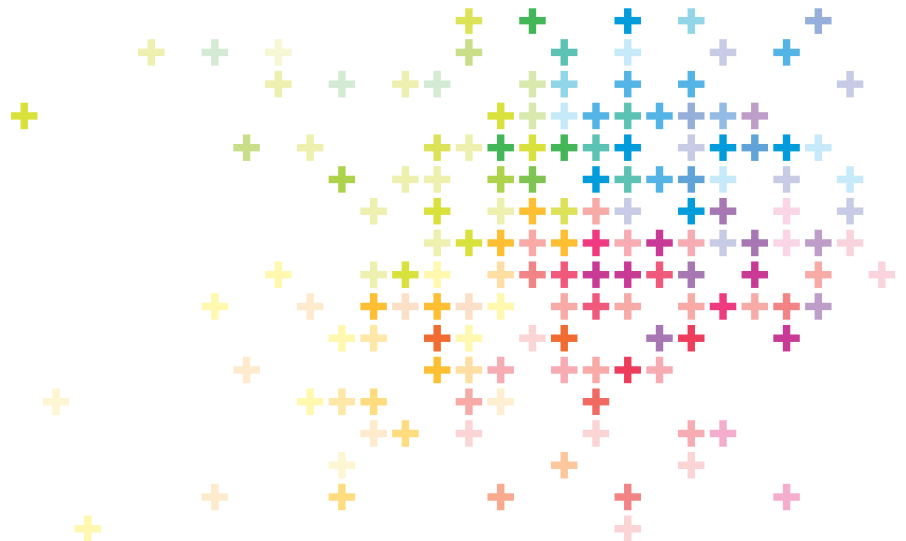

Fitting Guide

Coupling (S x S)

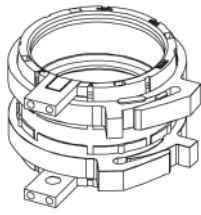

Electrofusion

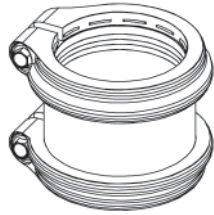

Fast-Lock

Bend 88.8° (1/4) (S x S)

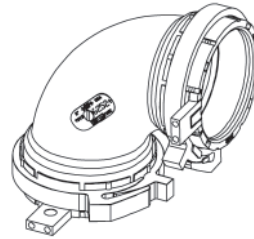

Electrofusion

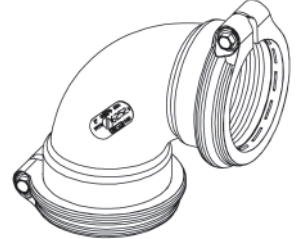

Fast-Lock

Bend 15° (1/24) - Street (S x SPG)

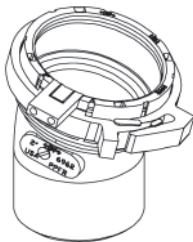

Electrofusion



Fast-Lock

Bend 88.8° (1/4) - Street (S x SPG)

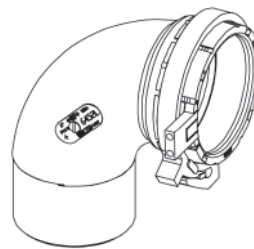

Electrofusion

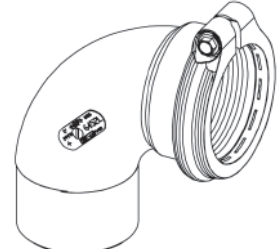

Fast-Lock

Bend 30° (1/12) - Street (S x SPG)



Electrofusion

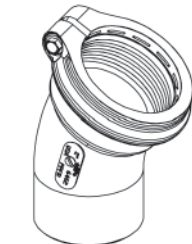

Fast-Lock

Bend 88.8° (1/4) - Long Sweep (S x S)

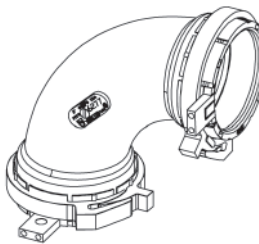

Electrofusion

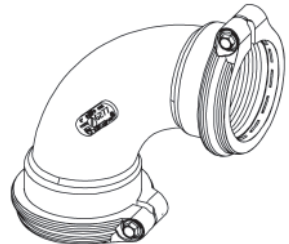

Fast-Lock

Bend 45° (1/8) (S x S)



Electrofusion



Fast-Lock

Bend 88.8° (1/4) - Long Sweep Street (S x SPG)

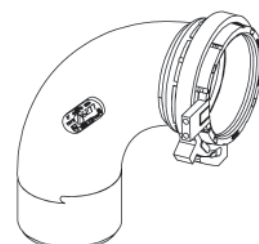

Electrofusion

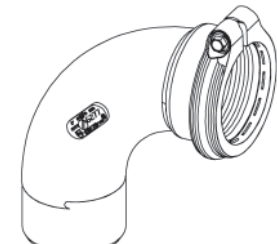

Fast-Lock

Bend 45° (1/8) - Street (S x SPG)

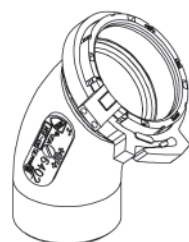

Electrofusion

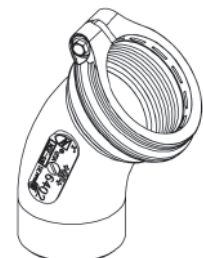

Fast-Lock

Bend 3-Way 88.8° (1/4) (S x S x S)

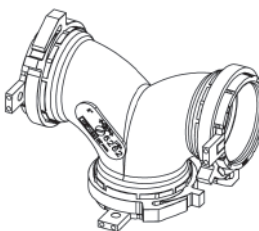

Electrofusion

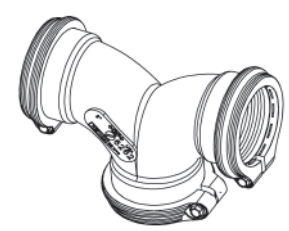

Fast-Lock

Fitting Guide (continued)

Reducing Bushing - Street (SPG x S)

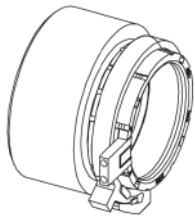

Electrofusion

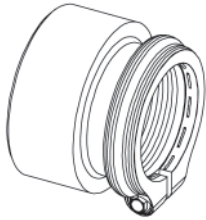

Fast-Lock

Cap (S)

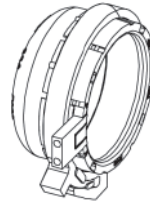

Electrofusion

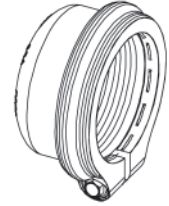

Fast-Lock

Female Adapter (S x FPT) / Female Adapter (S x BSP)

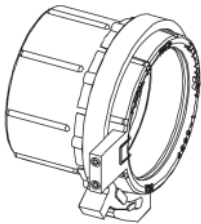

Electrofusion

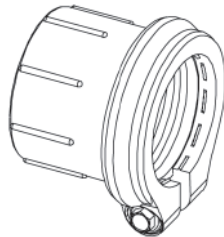

Fast-Lock

Cleanout Adapter with Plug - Street (SPG x FT)

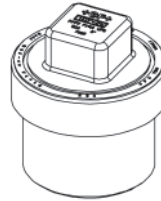

Spigot

Male Adapter (S x FPT) / Male Adapter (S x BSP)

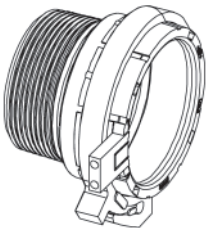

Electrofusion

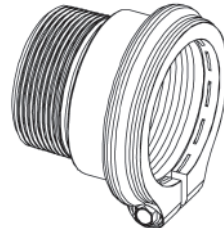

Fast-Lock

P-Trap (S x S)

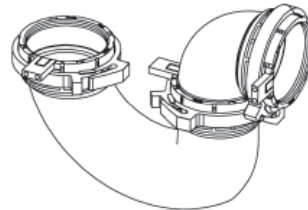

Electrofusion

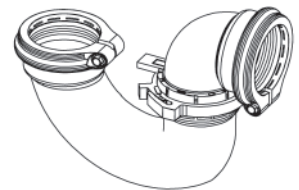

Fast-Lock

Flange - V.S. ANSI 150lb (S) / Flange - V.S. DIN (PN10) (S)

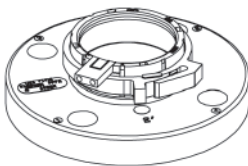

Electrofusion

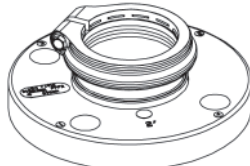

Fast-Lock

P-Trap with Union Connection (S x S)

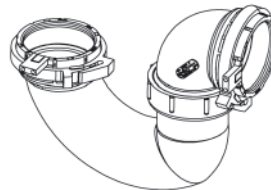

Electrofusion

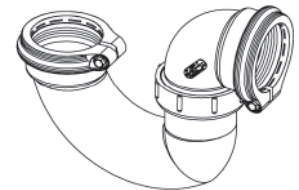

Fast-Lock

Metal Transition Fitting (Weld x SPG)

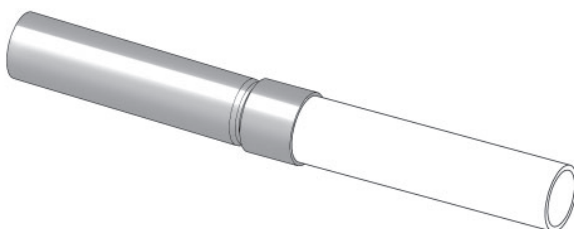

Spigot

Fitting Guide (continued)

Double Branch Tee 90° Corner Connector - Street (S x S x S x SPG)

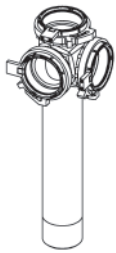

Electrofusion



Fast-Lock

Double Branch Tee 135° Corner Connector - Street (S x S x S x SPG)



Electrofusion

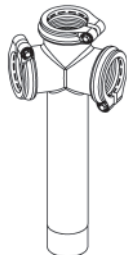

Fast-Lock

Double Branch Wye 90° Corner Connector - Street (S x S x S x SPG)

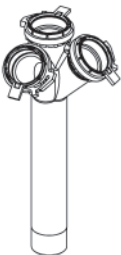

Electrofusion

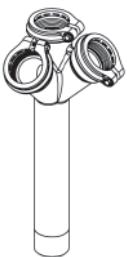

Fast-Lock

Drain Scupper (S)

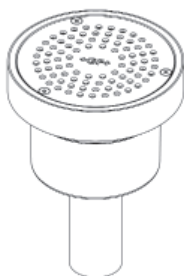

Open Deck

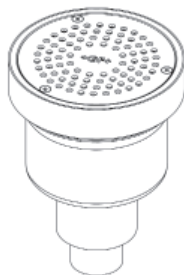

Class A0 - A60

Socket / Spigot Dimensions

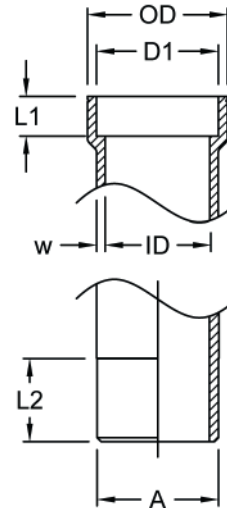

Socket / Spigot Dimensions (inches)

Nom. (inch)	OD (inch)	D1 (inch)	ID (inch)	W (inch)	L1 (inch)	L2 (inch)	A (inch)
1½"	2.2	1.9	1.5	0.14	0.76	0.88	1.90
2"	2.7	2.4	1.9	0.15	0.88	1.00	2.38
2½"	3.3	2.9	2.5	0.20	0.88	1.00	2.88
3"	4.0	3.5	2.8	0.22	0.88	1.06	3.50
4"	5.0	4.5	3.7	0.24	0.88	1.06	4.50
6"	7.2	6.6	5.6	0.28	1.26	1.38	6.63

Socket / Spigot Dimensions (mm)

Nom. (DN)	OD (mm)	D1 (mm)	ID (mm)	W (mm)	L1 (mm)	L2 (mm)	A (mm)
40	55.9	48.3	38.1	3.6	19.3	22.4	48.3
50	68.6	61.0	48.3	3.8	22.4	25.4	60.5
65	83.8	73.7	63.5	5.1	22.4	25.4	73.2
80	101.6	88.9	71.1	5.6	22.4	26.9	88.9
100	127.0	114.3	94.0	6.1	22.4	26.9	114.3
150	182.9	167.6	142.2	7.1	32.0	35.1	168.4

SeaDrain[®] White

Marine Drainage

I	Product Guide	
II	General Properties	
III	Design and Engineering	
IV	Installation	
V	Jointing Technologies	
VI	Special Considerations	

Sewage, black and gray water

Wastewater from sinks and showers as well as from toilets and medical facilities, creates gray and black water that has to be conveyed safely to the wastewater treatment system on board. With the solutions from GF Piping Systems, a safe transport is guaranteed. Our modern electrofusion or mechanical joining technology is conducive to fast installation. The highly diversified component mix provides installers with the flexibility they require. SeaDrain® White does not corrode, providing a long service life.



Your key benefits

- Thanks to fixed jointing the bracketry distance can be increased.
- Flexible and fast installation
- Electrofusion and SeaDrain Fast-Lock® guarantee no leakage or vacuum drop over entire lifespan
- Highest level of corrosion resistance and resulting durability

Product Guide

Content

1	Pipe	2
2	Couplers and Sockets	3
3	Bends and Elbows	4
4	Tees, Y-Pieces & Crosses	9
5	Reducers	14
6	Caps and End Caps	16
7	Adapters and Transitions	17
8	Flange Connections	21
9	Cleanouts, Floor Drains, Traps and Miscellaneous	22
10	Fusion and Fast-Lock Accessories	29
11	Part Number Index	33

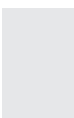
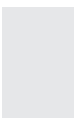
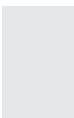
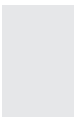
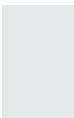

1 Pipe

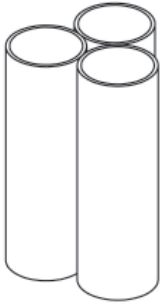

Schedule 40 UV White PPFR x 10ft

Size (inch)	DN (mm)	lengths (ft)	Code	avg. od (inch)	min. wall (inch)	avg. od (mm)	min. wall (mm)	Weight (lbs/ft)	Weight (kg/m)
1 ½	40	10	37D013015	1.900	0.145	48.3	3.7	0.33	0.49
2	50	10	37D013020	2.375	0.154	60.3	3.9	0.44	0.66
2 ½	65	10	37D013025	2.875	0.203	73.0	5.2	0.70	1.04
3	80	10	37D013030	3.500	0.216	88.9	5.5	0.91	1.36
4	100	10	37D013040	4.500	0.237	114.3	6.0	1.30	1.94
6	150	10	37D013060	6.625	0.280	168.3	7.1	2.28	3.41

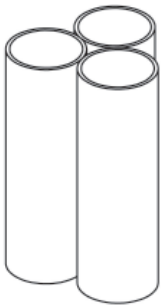
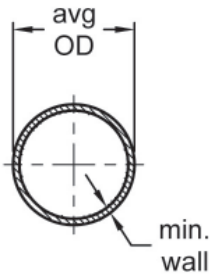

Schedule 40 UV White PPFR x 20ft

Size (inch)	DN (mm)	lengths (ft)	Code	avg. od (inch)	min. wall (inch)	avg. od (mm)	min. wall (mm)	Weight (lbs/ft)	Weight (kg/m)
1 ½	40	20	37D023015	1.900	0.145	48.3	3.7	0.33	0.49
2	50	20	37D023020	2.375	0.154	60.3	3.9	0.44	0.66
2 ½	65	20	37D023025	2.875	0.203	73.0	5.2	0.70	1.04
3	80	20	37D023030	3.500	0.216	88.9	5.5	0.91	1.36
4	100	20	37D023040	4.500	0.237	114.3	6.0	1.30	1.94
6	150	20	37D023060	6.625	0.280	168.3	7.1	2.28	3.41

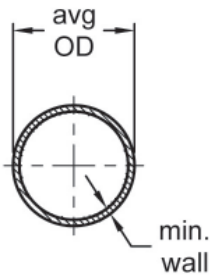

2 Couplers and Sockets

Coupling (S x S)



Size (inch)	DN (mm)	Electrofusion Code	Fast-Lock Code	N (inch)	N (mm)
1 ½	40	37D170001	378 170 001	0.06	1.5
2	50	37D170002	378 170 002	0.06	1.5
2 ½	65	37D170025	378 170 025	0.13	3.3
3	80	37D170003	378 170 003	0.13	3.3
4	100	37D170004	378 170 004	0.13	3.3
6	150	37D170006		0.19	4.8

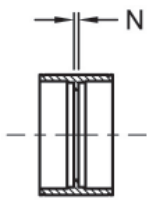

Sleeve Coupling (S x S)

4" & 6" Sleeve Couplings Require Metal Clamps



Size (inch)	DN (mm)	Electrofusion Code	L (inch)	L (mm)
1 ½	40	37D170401	1.56	40
2	50	37D170402	1.81	46
2 ½	65	37D170425	2.01	51
3	80	37D170403	2.00	51
4	100	37D170404	2.00	51
6	150	37D170406	2.69	68

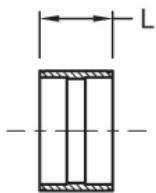

3 Bends and Elbows

SeaDrain 1/24 Bend PPFR Bend - (S x SPG) 15°



Size (inch)	DN (mm)	Electrofusion Code	Fast-Lock Code	J (inch)	K (inch)	J (mm)	K (mm)
1 ½	40	37D169601	378 169 601	0.62	1.66	16	42
2	50	37D169602	378 169 602	0.63	1.75	16	52
2 ½	65	37D169625	378 169 625	0.53	2.00	13	50
3	80	37D169603	378 169 603	0.81	2.37	21	60
4	100	37D169604	378 169 604	0.88	2.38	22	60

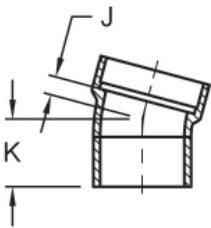

SeaDrain 1/12 Bend PPFR Street (S x SPG) 30°



Size (inch)	DN (mm)	Electrofusion Code	Fast-Lock Code	J (inch)	K (inch)	BC (mm)	K (mm)
1 ½	40	37D164601	378 164 601	0.75	2.03	19	51
2	50	37D164602	378 164 602	0.88	2.26	22	57
2 ½	65	37D164625	378 164 625	1.08	2.56	27	65
3	80	37D164603	378 164 603	1.25	2.81	32	71
4	100	37D164604	378 164 604	1.50	3.01	38	76

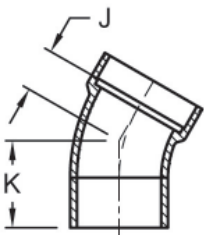

**SeaDrain 1/8 Bend PPFR
Bend - (S x S) 45°**



Size (inch)	DN (mm)	Electrofusion Code	Fast-Lock Code	J (inch)	J (mm)
1 ½	40	37D165001	378 165 001	1.13	29
2	50	37D165002	378 165 002	1.50	38
2 ½	65	37D165025	378 165 025	1.68	43
3	80	37D165003	378 165 003	1.75	44
4	100	37D165004	378 165 004	2.19	56
6	150	37D165006		3.37	86

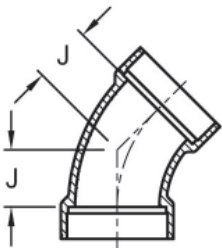

**SeaDrain 1/8 Bend PPFR
Street (S x SPG) 45°**



Size (inch)	DN (mm)	Electrofusion Code	Fast-Lock Code	J (inch)	K (inch)	J (mm)	K (mm)
1 ½	40	37D164001	378 164 001	1.13	2.74	29	62
2	50	37D164002	378 164 002	1.50	2.50	38	64
2 ½	65	37D164025	378 164 025	1.68	3.15	43	80
3	80	37D164003	378 164 003	1.75	3.40	44	83
4	100	37D164004	378 164 004	2.19	4.01	56	83
6	150	37D164006		3.38	4.75	86	121

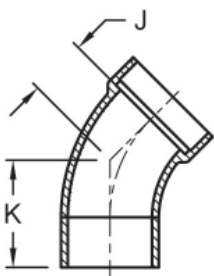

**SeaDrain 1/4 Bend PPFR
Bend - (S x S) 88.8°**

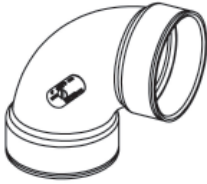

Size (inch)	DN (mm)	Electrofusion Code	Fast-Lock Code	G (inch)	G (mm)
1 ½	40	37D182501	378 182 501	1.75	44
2	50	37D182502	378 182 502	2.31	59
2 ½	65	37D182525	378 182 525	3.21	82
3	80	37D182503	378 182 503	3.06	78
4	100	37D182504	378 182 504	3.88	99
6	150	37D182506		5.63	143

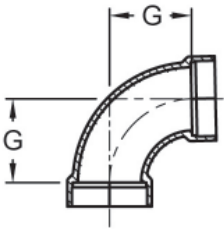

**SeaDrain 1/4 Bend PPFR
Street (S x SPG) 88.8°**



Size (inch)	DN (mm)	Electrofusion Code	Fast-Lock Code	G (inch)	K (inch)	G (mm)	K (mm)
1 ½	40	37D164501	378 164 501	1.75	3.11	44	79
2	50	37D164502	378 164 502	2.31	3.70	59	94
2 ½	65	37D164525	378 164 525	3.21	4.75	82	121
3	80	37D164503	378 164 503	3.06	4.75	78	121
4	100	37D164504	378 164 504	3.88	5.38	99	137
6	150	37D164506		11.00	10.81	279	275

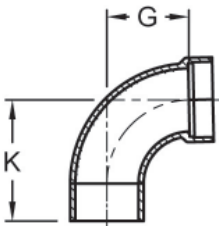

**SeaDrain 1/4 Bend PPFR
Long Sweep (S x S) 88.8°**

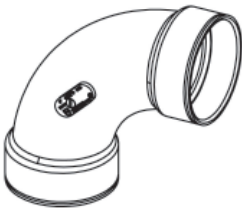

Size (inch)	DN (mm)	Electrofusion Code	Fast-Lock Code	G (inch)	G (mm)
1 1/2	40	37D162701	378 162 701	2.75	70
2	50	37D162702	378 162 702	3.25	83
3	80	37D162703	378 162 703	4.06	130
4	100	37D162704	378 162 704	4.94	125

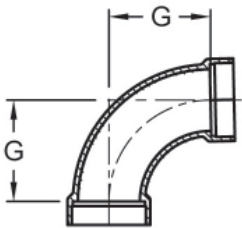

**SeaDrain 1/4 Bend PPFR
Long Sweep Street (S x SPG) 88.8°**



Size (inch)	DN (mm)	Electrofusion Code	Fast-Lock Code	G (inch)	K (inch)	G (mm)	K (mm)
1 1/2	40	37D162901	378 162 901	2.75	4.29	70	109
2 1/2	65	37D162925	378 162 925	4.00	5.53	102	140

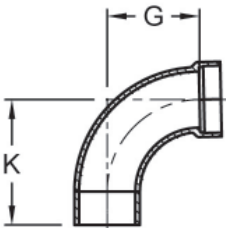

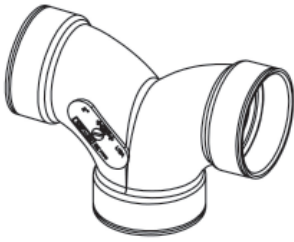

SeaDrain 3-way 1/4 Bend PPFR
3-Way Bend (S x S x S) 88.8°

Size (inch)	DN (mm)	Electrofusion Code	Fast-Lock Code	G (inch)	G (mm)
1 1/2	40	37D162601	378 162 601	1.75	44
2	50	37D162602	378 162 602	2.31	59

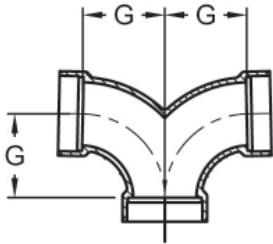

4 Tees, Y-Pieces & Crosses

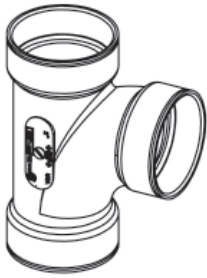

Branch Tee 88.8° (S x S x S)

Size (inch)	DN (mm)	Electrofusion Code	Fast-Lock Code	G (inch)	N (inch)	G (mm)	N (mm)
1 ½	40	37D161501	378 161 501	1.75	2.75	44	70
2	50	37D161502	378 161 502	2.31	3.69	59	94
3	80	37D161503	378 161 503	3.06	4.88	78	124
4	100	37D161504	378 161 504	3.88	6.13	99	156

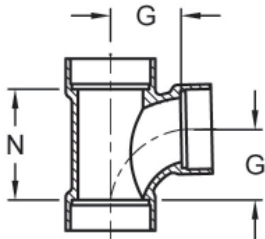

Branch Tee 88.8° - Street (S x S x SPG)

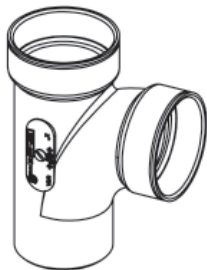

Size (inch)	DN (mm)	Electrofusion Code	Fast-Lock Code	G (inch)	G1 (inch)	N (inch)	G (mm)	G1 (mm)	N (mm)
1 ½	40	37D161601	378 161 601	1.75	3.05	4.05	65	77	101
2 ½	65	37D161625	378 161 625	2.56	3.98	5.43	65	101	83
3	80	37D161603	378 161 603	3.02	4.56	6.43	77	116	102
4	100	37D161604	378 161 604	3.87	5.35	7.68	98	136	105

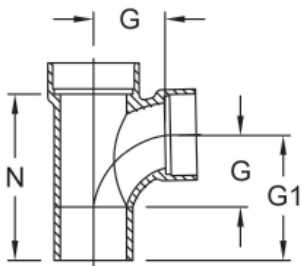

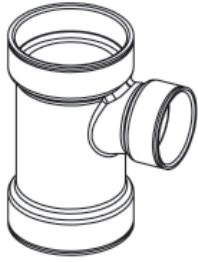

Reducing Branch Tee 88.8° (S x S x S)

Size (inch)	DN (mm)	Electrofusion Code	Fast-Lock Code	GJ (inch)	GK (inch)	N (inch)	GJ (mm)	GK (mm)	N (mm)
2 x 1 1/2	50 x 40	37D161530	378 161 530	1.96	2.21	3.17	50	56	81
3 x 1 1/2	80 x 40	37D161531	378 161 531	1.75	2.56	2.68	44	65	68
3 x 2	80 x 50	37D161532	378 161 532	2.13	2.88	3.31	54	73	84
4 x 2	100 x 50	37D161534	378 161 534	2.06	3.31	3.19	52	84	81
4 x 3	100 x 80	37D161535	378 161 535	3.00	3.56	4.75	76	90	121
6 x 4	150 x 100	37D161539		3.93	4.90	6.13	100	124	156

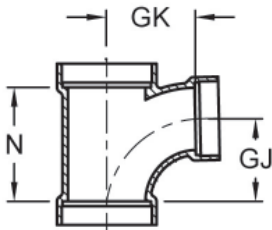

Reducing Branch Tee 88.8° - Street (S x S x SPG)

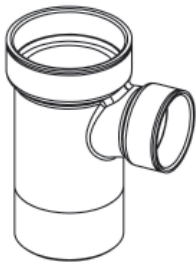

Size (inch)	DN (mm)	Electrofusion Code	Fast-Lock Code	GK (inch)	GJ (inch)	N (inch)	GK (mm)	GJ (mm)	N (mm)
2 1/2 x 1 1/2	65 x 40	37D161628	378 161 628	2.56	3.98	5.49	65	101	139
3 x 1 1/2	80 x 40	37D161631	378 161 631	3.02	3.25	4.19	77	83	106
3 x 2 1/2	80 x 65	37D161629	378 161 629	3.02	4.00	5.54	77	102	141
4 x 1 1/2	100 x 40	37D161633	378 161 633	3.87	4.12	5.03	98	105	128
4 x 2 1/2	100 x 65	37D161627	378 161 627	3.87	4.00	5.61	98	102	142
4 x 3	100 x 80	37D161635	378 161 635	3.87	4.50	6.37	98	114	162

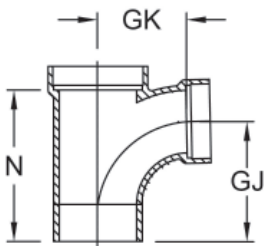

Double Reducing Branch Tee 88.8° - Street (S x S x S x SPG)

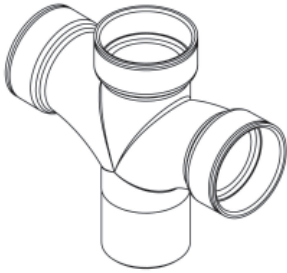

Size (inch)	DN (mm)	Electrofusion Code	Fast-Lock Code	G (inch)	N (inch)	G1 (inch)	G (mm)	N (mm)	G1 (mm)
1 1/2 x 1 1/2	40 x 40	37D161701	378 161 701	3.00	4.74	4.00	76	120	102
2 1/2 x 1 1/2	65 x 40	37D161728	378 161 728	3.00	4.56	3.50	76	116	89
4 x 1 1/2	100 x 40	37D161733	378 161 733	3.00	5.56	3.50	76	141	89

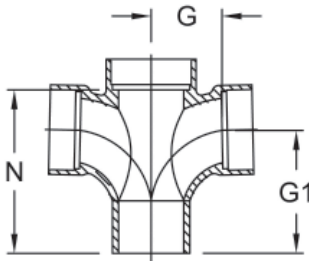

Branch Wye 45° (S x S x S)



Size (inch)	DN (mm)	Electrofusion Code	Fast-Lock Code	GJ (inch)	GN (inch)	N (inch)	GJ (mm)	GN (mm)	N (mm)
1 1/2	40	37D163001	378 163 001	2.88	1.13	4.00	73	29	102
2	50	37D163002	378 163 002	3.63	1.38	5.00	92	35	127
3	80	37D163003	378 163 003	5.00	1.63	6.63	127	41	168
4	100	37D163004	378 163 004	6.38	1.88	8.25	162	48	210
6	150	37D163006	378 163 006	9.13	1.63	10.75	232	41	273

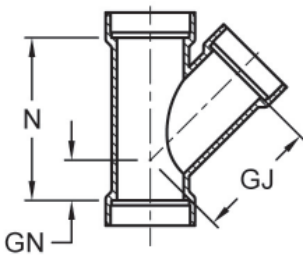



Reducing Branch Wye 45° (S x S x S)

Size (inch)	DN (mm)	Electrofusion Code	Fast-Lock Code	GJ (inch)	GN (inch)	N (inch)	GJ (mm)	GN (mm)	N (mm)
2 x 1 1/2	50 x 40	37D163030	378 163 030	3.44	1.06	4.38	87	27	111
3 x 1 1/2	80 x 40	37D163031	378 163 031	6.25	0.88	5.00	159	22	127
3 x 2	80 x 50	37D163032	378 163 032	4.63	0.88	5.00	118	22	127
4 x 2	100 x 50	37D163034	378 163 034	5.56	0.38	5.06	141	10	129
4 x 3	100 x 80	37D163035	378 163 035	6.00	1.06	6.63	152	27	168
6 x 2	150 x 50	37D163037		6.75	-1.13	4.73	171	-29	120
6 x 3	150 x 80	37D163038		7.43	0.19	6.38	189	5	162
6 x 4	150 x 100	37D163039		7.75	0.68	7.73	197	17	196

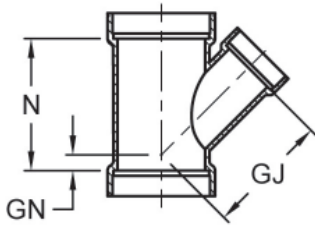

Branch Wye 45° - Street (S x S x SPG)



Size (inch)	DN (mm)	Electrofusion Code	Fast-Lock Code	GJ (inch)	GN (inch)	N (inch)	GJ (mm)	GN (mm)	N (mm)
1 1/2	40	37D163101	378 163 101	2.88	2.43	5.30	73	62	135
2 1/2	65	37D163125	378 163 125	4.56	3.00	7.56	116	76	192
3	80	37D163103	378 163 103	5.00	3.13	8.13	127	80	207
4	100	37D163104	378 163 104	6.38	3.38	9.76	162	86	248
6	150	37D163106		9.13	3.12	12.23	232	79	311

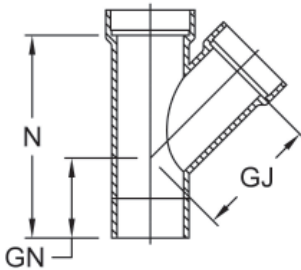

Reducing Branch Wye 45° - Street (S x S x SPG)



Size (inch)	DN (mm)	Electrofusion Code	Fast-Lock Code	GJ (inch)	GN (inch)	N (inch)	GJ (mm)	GN (mm)	N (mm)
2 1/2 x 1 1/2	65 x 40	37D163128	378 163 128	3.65	3.00	6.42	93	76	163
3 x 1 1/2	80 x 40	37D163131	378 163 131	4.09	3.13	7.01	104	80	178
3 x 2 1/2	80 x 65	37D163129	378 163 129	5.00	3.23	8.13	127	82	207
4 x 1 1/2	100 x 40	37D163133	378 163 133	5.00	3.00	7.65	127	76	194
4 x 2 1/2	100 x 65	37D163127	378 163 127	5.62	3.00	8.37	143	76	213
4 x 3	100 x 80	37D163135	378 163 135	6.00	2.56	8.37	152	65	213
6 x 4	150 x 100	37D163139		8.50	2.18	10.23	216	55	260

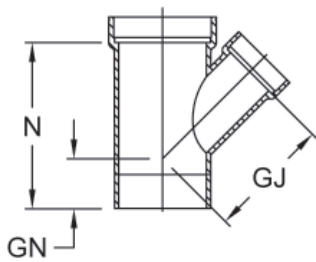

Double Branch Wye 45° (S x S x S x S)



Size (inch)	DN (mm)	Electrofusion Code	Fast-Lock Code	GJ (inch)	GN (inch)	N (inch)	GJ (mm)	GN (mm)	N (mm)
1 1/2	40	37D163501	378 163 501	3.50	1.13	4.63	89	29	118
2	50	37D163502	378 163 502	4.00	1.38	5.38	102	35	137
2 1/2	65	37D163525	378 163 525	4.56	1.50	6.06	116	38	154
3	80	37D163503	378 163 503	5.00	1.63	7.63	127	41	194
4	100	37D163504	378 163 504	6.38	1.88	9.25	162	48	235

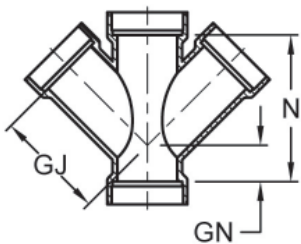

5 Reducers

Eccentric Pipe Increaser - Street (SPG x S)

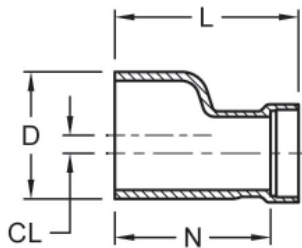
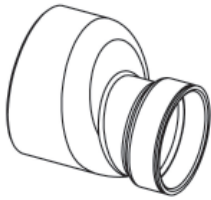

Size (inch)	DN (mm)	Electrofusion Code	Fast-Lock Code
2 x 1 1/2	50 x 40	37D171030	378 171 030
2 1/2 x 1 1/2	65 x 40	37D171028	378 171 028
2 1/2 x 2	65 x 50	37D171021	378 171 021
3 x 1 1/2	80 x 40	37D171031	378 171 031
3 x 2	80 x 50	37D171032	378 171 032
3 x 2 1/2	80 x 65	37D171029	378 171 029
4 x 1 1/2	100 x 40	37D171033	378 171 033
4 x 2	100 x 50	37D171034	378 171 034
4 x 2 1/2	100 x 65	37D171027	378 171 027
4 x 3	100 x 80	37D171035	378 171 035
6 x 1 1/2	150 x 40	37D171036	
6 x 2	150 x 50	37D171037	
6 x 2 1/2	150 x 65	37D171026	
6 x 3	150 x 80	37D171038	
6 x 4	150 x 100	37D171039	

D (inch)	L (inch)	N (inch)	CL (inch)	D (mm)	L (mm)	N (mm)	CL (mm)
2.38	3.78	3.02	0.23	61	96	77	6
2.88	3.26	2.50	0.43	73	83	64	11
2.88	4.11	3.17	0.20	73	104	81	5
3.50	3.43	2.67	0.72	89	87	68	18
3.50	4.33	3.39	0.49	89	110	86	12
3.50	3.40	2.46	0.29	89	86	63	7
4.50	3.72	2.96	1.20	114	95	75	31
4.50	4.73	3.79	1.93	114	120	96	49
4.50	3.79	2.85	0.76	114	96	72	19
4.50	3.66	2.72	0.47	114	93	69	12
6.63	4.60	3.87	2.22	168	117	98	56
6.63	5.25	4.31	1.98	168	133	110	50
6.63	4.26	3.32	1.79	168	108	84	46
6.63	4.26	3.32	1.49	168	108	84	38
6.63	4.26	3.32	1.01	168	108	84	26

Pipe Increaser (S x S)

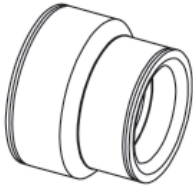

Size (inch)	DN (mm)	Electrofusion Code	Fast-Lock Code	N (inch)	N (mm)
1 1/2 x 2	40 x 50	37D170230	378 170 230	0.53	14
2 x 3	50 x 80	37D170232	378 170 232	0.88	22
2 x 4	50 x 100	37D170234	378 170 234	1.38	35
3 x 4	80 x 100	37D170235	378 170 235	0.94	24

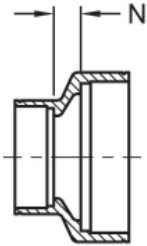

Reducer Bushing - Street (SPG x S)



Size (inch)	DN (mm)	Electrofusion Code	Fast-Lock Code	N (inch)	N (mm)
2 x 1 1/2	50 x 40	37D187530	378 187 530	1.61	41
3 x 1 1/2	80 x 40	37D187531	378 187 531	1.50	38
3 x 2	80 x 50	37D187532	378 187 532	1.50	38
4 x 2	100 x 50	37D187534	378 187 534	1.63	41
4 x 3	100 x 80	37D187535	378 187 535	1.50	38
6 x 4	150 x 100	37D187539		1.28	33



6 Caps and End Caps

SeaDrain Cap PPFR Cap (S)

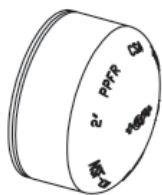

Size (inch)	DN (mm)	Electrofusion Code	Fast-Lock Code	HL (inch)	HL (mm)
1 ½	40	37D170801	378 170 801	0.32	8
2	50	37D170802	378 170 802	0.53	14
2 ½	65	37D170825	378 170 825	0.91	23
3	80	37D170803	378 170 803	0.91	24
4	100	37D170804	378 170 804	1.09	28
6	150	37D170806		1.56	40

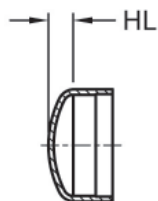

7 Adapters and Transitions

SeaDrain Adapter PPR Female Adapter (S x FPT)

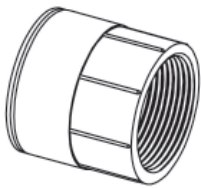

DN (mm)	Thread Type	Size (inch)	Electrofusion Code	Fast-Lock Code	HL (inch)	HL (mm)
40	NPT	1	37D168923	378 168 923	1.00	25
40	NPT	1 ¼	37D168922	378 168 922	1.06	27
40	NPT	1 ½	37D168901	378 168 901	1.12	28
40	NPT	2	37D168930	378 168 930	1.15	29
50	NPT	2	37D168902	378 168 902	1.15	29
80	NPT	3	37D168903	378 168 903	1.72	45
100	NPT	4	37D168904	378 168 904	1.81	46

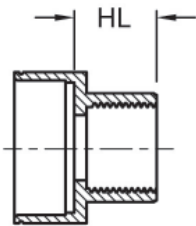

SeaDrain Adapter PPR Male Adapter (S x MPT)

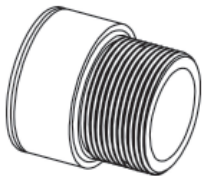

DN (mm)	Thread Type	Size (inch)	Electrofusion Code	Fast-Lock Code	HL (inch)	HL (mm)
40	NPT	1	37D168723	378 168 723	1.06	27
40	NPT	1 ¼	37D168722	378 168 722	1.12	28
40	NPT	1 ½	37D168701	378 168 701	1.18	30
40	NPT	2	37D168730	378 168 730	1.25	32
50	NPT	2	37D168702	378 168 702	1.25	32
80	NPT	3	37D168703	378 168 703	1.84	47
100	NPT	4	37D168704	378 168 704	2.00	51

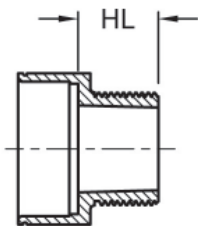

SeaDrain Adapter PPR
Female Adapter (S x BSP)

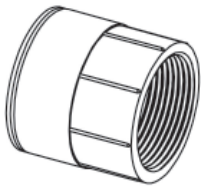

DN (mm)	Size (inch)	Thread BSP (inch)	Electrofusion Code	Fast-Lock Code	HL (inch)	HL (mm)
40	1 ½	1	37D168123	378 168 123	1.00	25
40	1 ½	1 ¼	37D168122	378 168 122	1.06	27
40	1 ½	1 ½	37D168101	378 168 101	1.12	28
40	1 ½	2	37D168130	378 168 130	1.15	29
50	2	2	37D168102	378 168 102	1.15	29

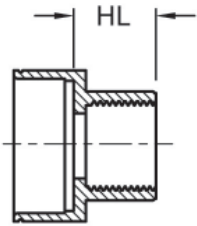

SeaDrain Adapter PPR
Male Adapter (S x BSP)

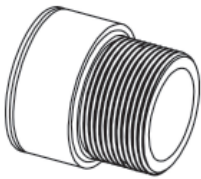

Size (inch)	Nominal Size (mm)	Thread BSP (inch)	Electrofusion Code	Fast-Lock Code	HL (inch)	HL (mm)
1 ½	50	1	37D168823	378 168 823	1.06	27
1 ½	50	1 ¼	37D168822	378 168 822	1.12	28
1 ½	50	1 ½	37D168801	378 168 801	1.25	32
1 ½	50	2	37D168830	378 168 830	1.18	30
2	63	2	37D168802	378 168 802	1.25	32

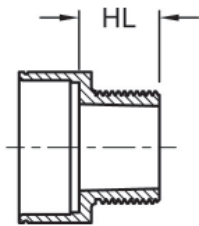

Metal Transition Fitting (Weld x SPG)

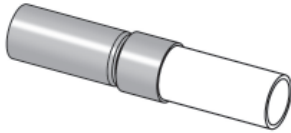

Instruments:

- USPH Compliant Transition

Size (inch)	DN (mm)	T316SS Code	L (inch)	L1 (inch)	L2 (inch)	X (inch)	X1 (inch)	L (mm)	L1 (mm)	L2 (mm)	X (mm)	X1 (mm)
1 1/2	40	37D188901	21.69	10.75	9.69	1.90	1.90	551	273	246	48	48
2	50	37D188902	21.96	10.50	10.00	2.38	2.38	558	267	254	61	61
2 1/2	65	37D188925	22.38	10.00	10.38	2.88	2.88	568	254	264	73	73

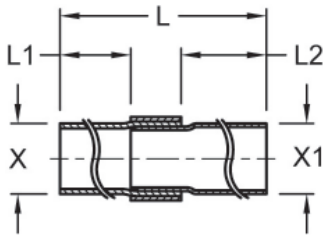

Blucher Transition Fitting (Push x SPG)

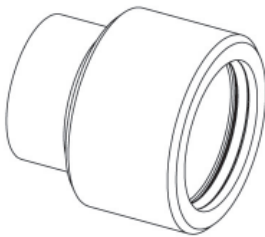

Size (inch)	DN (mm)	Blucher (mm)	Code
1 1/2	40	50	37D187640
2 1/2	65	75	37D187665
4	100	110	37D187610
6	150	160	37D187615

D (inch)	L (inch)	L1 (inch)	D1 (inch)	D2 (inch)	D (mm)	L (mm)	L1 (mm)	D1 (mm)	D2 (mm)
1.90	3.59	1.50	2.01	2.80	48.3	91.2	38.1	51.1	71.1
2.88	3.90	1.50	2.99	3.94	73.0	99.1	38.1	75.9	100.1
4.50	4.18	1.50	4.37	5.43	114.3	106.2	38.1	111.0	137.9
6.63	4.77	1.50	6.34	7.68	168.3	121.2	38.1	161.0	195.1

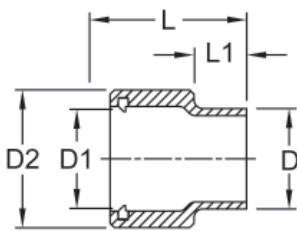

**SeaDrain Adapter PPR
Metal Transition Coupling**

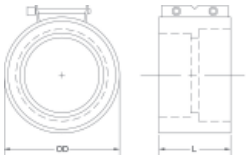

Size (inch)	DN-DN (mm)	Code	O.D. (inch)	L (inch)
1 ½	48 - 50	37D188870	3	2
1 ½	53 - 55	37D188800	3	2
2	53 - 55	37D188810	3	2
2	74 - 77	37D188820	4	2
3	75 - 76	37D188830	4	2
4	102 - 110	37D188840	5	2
6	159 - 160	37D188860	7	3

8 Flange Connections

Seadrain Van Stone Flange PPFR Flange (S) ANSI 150LB

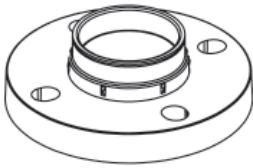

Size (inch)	DN (mm)	Electrofusion Code	Fast-Lock Code
1 ½	40	37D169301	378 169 301
2	50	37D169302	378 169 302
2 ½	65	37D169325	378 169 325
3	80	37D169303	378 169 303
4	100	37D169304	378 169 304
6	150	37D169306	

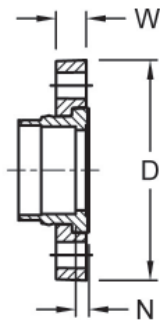

# holes	bolt hole dia. (inch)	bolt cir. dia. (inch)	D (inch)	N (inch)	W (inch)	bolt hole dia. (mm)	bolt cir- cle dia. (mm)	D (mm)	N (mm)	W (mm)
4	0.56	3.88	5.00	0.31	0.75	14	99	127	8	19.1
4	0.68	4.75	6.00	0.34	0.81	17	121	152	9	20.6
4	0.75	5.50	7.28	0.44	1.00	19	140	185	11	25.4
4	0.75	6.00	7.50	0.44	1.00	19	152	191	11	25.4
8	0.75	7.50	9.00	0.42	1.10	19	191	229	11	27.9
8	0.88	9.50	11.00	0.45	1.26	22	241	279	11	32.0

Seadrain Van Stone Flange PPFR Flange (S) DIN (PN10)

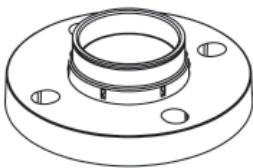

Size (inch)	DN (mm)	Electrofusion Code	Fast-Lock Code
1 ½	40	37D167301	378 167 301
2	50	37D167302	378 167 302
2 ½	65	37D167325	378 167 325
3	80	37D167303	378 167 303
4	100	37D167304	378 167 304
6	150	37D167306	

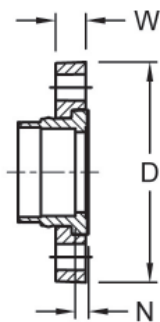

# holes	bolt hole dia. (inch)	bolt cir. dia. (inch)	D (inch)	N (inch)	W (inch)	bolt hole dia. (mm)	bolt cir- cle dia. (mm)	D (mm)	N (mm)	W (mm)
4	0.75	4.30	5.90	0.31	0.75	19	109	150	8	19.1
4	0.75	4.90	6.50	0.34	0.81	19	125	165	9	20.6
4	0.75	5.70	7.30	0.44	1.00	19	145	185	11	25.4
8	0.75	6.30	7.90	0.44	1.00	19	160	201	11	25.4
8	0.75	7.00	8.70	0.42	1.10	19	178	221	11	27.9
8	0.88	9.45	11.25	0.45	1.26	22	240	286	11	32.0

9 Cleanouts, Floor Drains, Traps and Miscellaneous.

Cleanout Adapter with Plug - Street (SPG x FT)

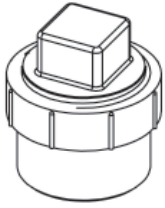

Size (inch)	DN (mm)	Code	HL (inch)	N (inch)	X (inch)	HL (mm)	N (mm)	X (mm)
1 ½	40	37D177001	0.78	2.09	1.90	20	53	48
2	50	37D177002	0.78	2.22	2.38	20	56	61
2 ½	65	37D177025	0.93	2.37	2.88	24	60	73
3	80	37D177003	1.09	2.66	3.50	28	68	89
4	100	37D177004	1.13	2.94	4.50	29	75	114
6	150	37D177006	1.31	2.63	6.63	33	67	168

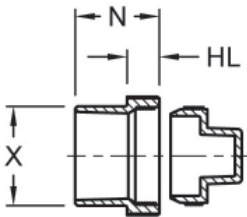

Cleanout Plug (MT)

Use with cleanout adapters only

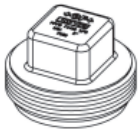

Size (inch)	Code	L (inch)	Q (inch)
1 ½	37D170501	1.56	1.00
2	37D170502	1.54	1.25
2 ½	37D170525	1.94	1.56
3	37D170503	2.03	1.63
4	37D170504	2.16	2.00
6	37D170506	2.38	2.38

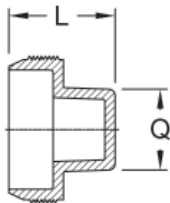

P-Trap (SxS)

1-1/2" - 4" U-Bend Joint must be fused in the field



Size (inch)	DN (mm)	Electrofusion Code	Fast-Lock Code
1 1/2	40	37D172001	378 172 001
2	50	37D172002	378 172 002
2 1/2	65	37D172025	378 172 025
3	80	37D172003	378 172 003
4	100	37D172004	378 172 004

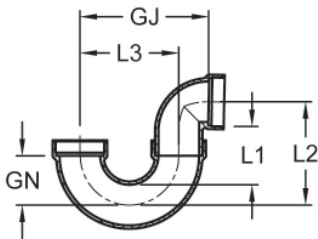

GJ (inch)	GN (inch)	L1 (inch)	L2 (inch)	L3 (inch)	GJ (mm)	GN (mm)	L1 (mm)	L2 (mm)	L3 (mm)
4.71	1.68	2.06	3.64	3.50	120	43	52	93	89
6.94	2.44	2.71	4.75	5.06	176	62	69	121	129
7.82	2.73	3.54	6.01	6.00	199	69	90	153	152
8.88	2.79	3.41	6.43	6.75	226	71	87	163	172
10.75	3.88	3.88	8.06	8.50	273	99	99	205	216

P-Trap with Union Connection (S x S)

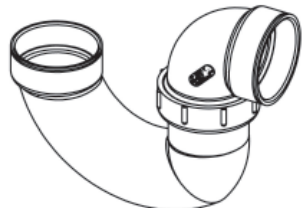

Size (inch)	DN (mm)	Electrofusion Code	Fast-Lock Code
1 1/2	40	37D172101	378 172 101

GJ (inch)	GN (inch)	L1 (inch)	L2 (inch)	L3 (inch)	GJ (mm)	GN (mm)	L1 (mm)	L2 (mm)	L3 (mm)
4.84	1.68	2.38	4.00	3.50	123	43	61	102	89

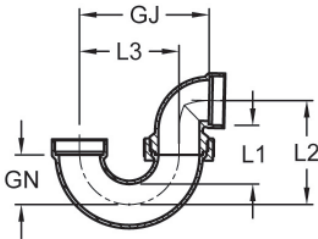

Double Branch Tee 90° Corner Connector - Street (S x S x S x SPG)

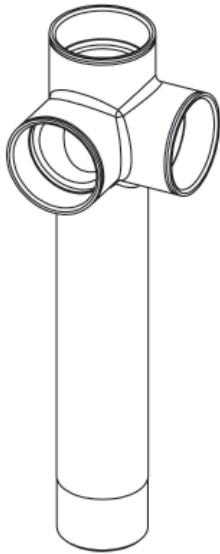

Size (inch)	DN (mm)	Electrofusion Code	Fast-Lock Code
1 1/2 x 1 1/2	40 x 40	37D162201	378 162 201
2 1/2 x 1 1/2	65 x 40	37D162228	378 162 228

G (inch)	N (inch)	L (inch)	G1 (inch)	G (mm)	N (mm)	L (mm)	G1 (mm)
1.30	11.27	12.03	10.00	47	286	306	254
1.84	11.27	12.21	10.00	33	286	310	254

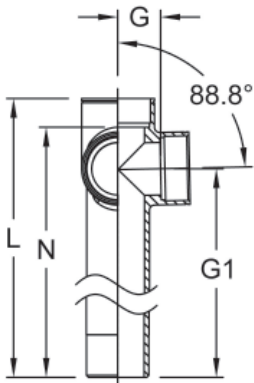
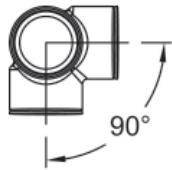

Double Branch Tee 135° Corner Connector - Street (S x S x S x SPG)

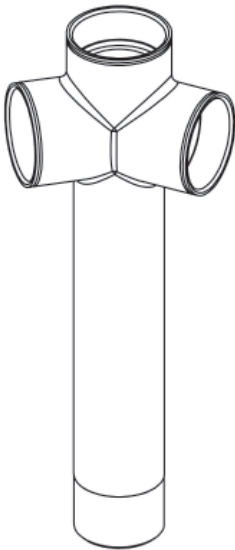

Size (inch)	DN (mm)	Electrofusion Code	Fast-Lock Code
1 1/2 x 1 1/2	40 x 40	37D162301	378 162 301
2 1/2 x 1 1/2	65 x 40	37D162328	378 162 328

G (inch)	N (inch)	L (inch)	G1 (inch)	G (mm)	N (mm)	L (mm)	G1 (mm)
1.30	11.39	12.15	10.00	33	289	309	254
1.84	11.36	12.30	10.00	47	289	312	254

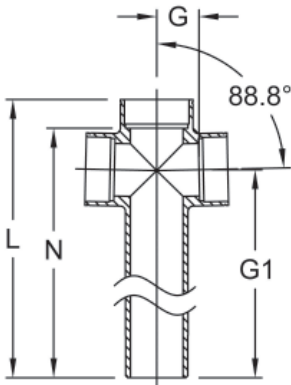
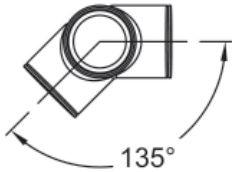

Double Branch Wye 90° Corner Connector - Street (S x S x S x SPG)

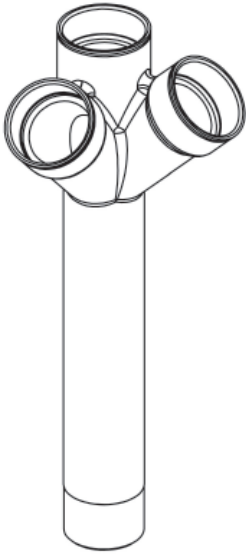

Size (inch)	DN (mm)	Electrofusion Code	Fast-Lock Code
1 1/2 x 1 1/2	40 x 40	37D162401	378 162 401
2 1/2 x 1 1/2	65 x 40	37D162428	378 162 428

G (inch)	N (inch)	L (inch)	G1 (inch)	G (mm)	N (mm)	L (mm)	G1 (mm)
3.07	13.18	13.95	10.00	78	335	354	254
3.84	13.61	14.55	10.00	98	346	370	254

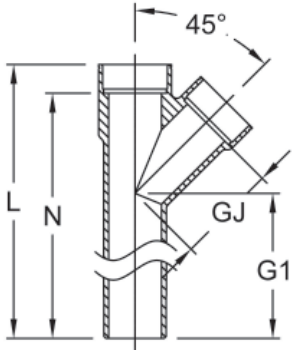
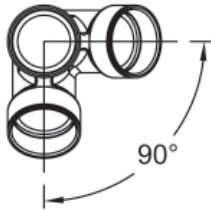

Drain Scupper (SPG) - Open Deck

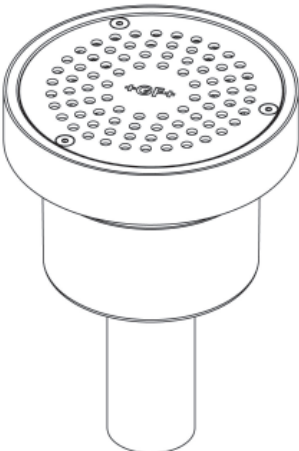

Outlet Size (inch)	DN (mm)	Steel Sleeve Code	Aluminum Sleeve Code	OD (inch)	L (inch)	Min. (inch)	Max. (inch)	OD (mm)	L (mm)	Min. (mm)	Max. (mm)
1 ½	40	37D181101	37D181301	6.6	9.0	6.4	9.0	168	229	163	229
2 ½	65	37D181125	37D181325	6.6	9.0	6.4	9.0	168	229	163	229

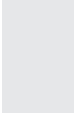
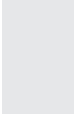
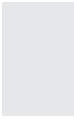
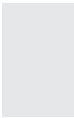
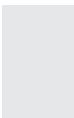
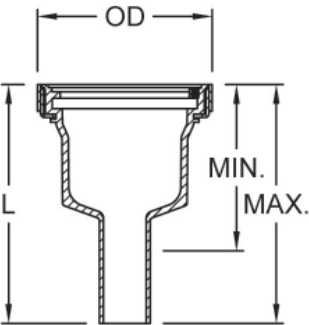
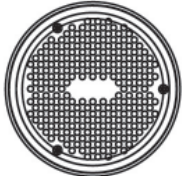



Drain Scupper (SPG) - Class A60

Outlet Size (inch)	DN (mm)	Fire Class	Steel Sleeve Code	OD (inch)	L (inch)	OD (mm)	L (mm)
1 ½	40	A60	37D181401	6.6	9.0	168	229
2 ½	65	A60	37D181425	6.6	8.8	168	224

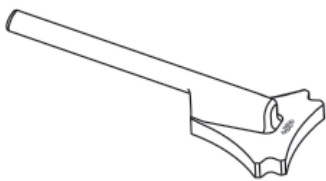
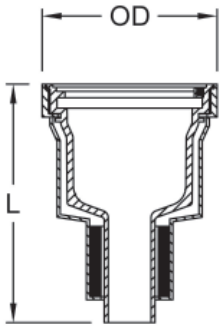
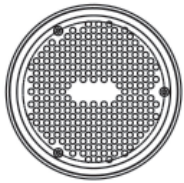

Drain Scupper Installation Wrench

Description	Code	weight	L	W	H	L	W	H
		(kg)	(inch)	(inch)	(inch)	(mm)	(mm)	(mm)
Drain Scupper Wrench (Aluminum)	37Z004844	0.64	12.18	5.20	3.62	309.4	132.1	91.9

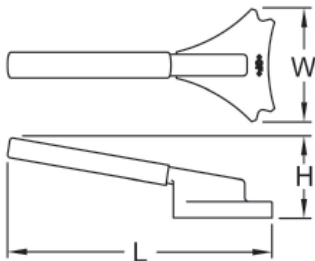

Drain Scupper Replacement Parts

Description	Code	Pack Qty
Drain Scupper Gasket	37Z002150	5
Drain Scupper Stainless Steel Cover	37Z003390	2
Drain Scupper Cover Screw Kit	37Z003404	25

10 Fusion and Fast-Lock Accessories

Fusion Locking Collar with Plastic Clamp

6" Fusion Locking Collars without plastic clamp
 6" Collar utilizes metal clamp part# 37Z000600

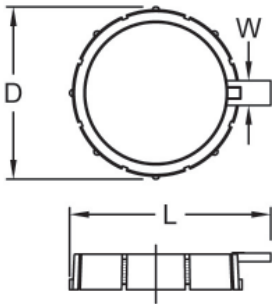
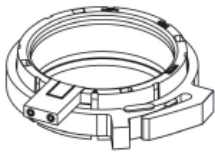

Size (inch)	Code	Pack Qty	D (inch)	L (inch)	W (inch)	D (mm)	L (mm)	W (mm)
1 ½	37D162801	10	2.62	3.17	0.62	66.5	80.5	15.6
2	37D162802	10	3.05	3.70	0.62	77.5	93.9	15.6
2 ½	37D162825	10	3.61	4.35	0.63	91.7	110.4	15.9
3	37D162803	10	4.32	4.86	0.63	109.7	123.4	15.9
4	37D162804	10	5.35	6.09	0.63	135.9	154.6	15.9
6	37D162806	10	7.46	7.97	0.63	189.5	202.5	15.9

Plastic Clamp

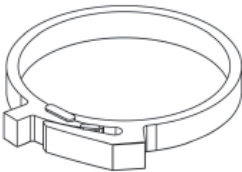

Size (inch)	Code	Pack Qty
1 ½	37A160601	10
2	37A160602	10
2 ½	37A160625	10
3	37A160603	10
4	37A160604	10

Channel Locks



Size (inch)	Code	Description	Pack Qty
1 1/2, 2, & 3	37X004817	440 Channel Locks	1
4	37X004818	460 Channel Locks	1

Metal Clamp

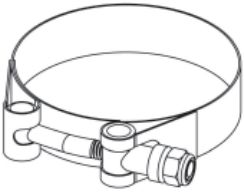

Size (inch)	Code	weight (lb)	Pack Qty
4	37Z000400	0.399	1
6	37Z000600	0.399	1



Metal Clamp Torque Tools

- Torque limiting tool for electrofusion metal clamps

Code	Description	Pack Qty
37Z000091	L-Handle Ratchet Torque Tool w/Socket - 65 in-lb	1
37Z000092	T-Handle Torque Tool w/Socket - 65 in-lb	1
37Z000090	Torque Tool Socket - 3/8" Drive	1



Fast-Lock MJ Kit

Includes Fast-Lock MJ Collar, Bolt, & Gasket



Size (inch)	Code	Pack Qty
1 ½	378 160 001	10
2	378 160 002	10
2 ½	378 160 025	10
3	378 160 003	10
4	378 160 004	10



Lock Ring Pliers

Code	Pack Qty
37Z000096	1



Fast-Lock MJ Lubricant

Note:

Food Grade Safe, Meets FDA: 21 CFR 175.300
Contains no hazardous ingredients according to GHS

Size (oz)	Size (grams)	Code
5	150	37Z000097



SeaDrain Fast-Lock™ Torque Test Kit

Code	weight (lb)
37X004832	0.99



Rotary Deburring/Chamfering Tool

Code	weight (lb)
790 205 072	0.066



Rotary Pipe Chamfering Tool

- Chamfering tool (15° bevel) for plastic pipes. Fast and reliable adjustment to the different pipe diameters and wall thickness.
- Easy adjustment to the different pipe diameters and wall thickness.

Code	weight (lb)	d-d (mm)
790 309 003	2.866	25 - 200



Cleaner

- DVGW approved
- Special cleaning agent for plastic fusion connections with PP, PE, PVDF and PB.

Code	weight (lb)	Size
799 298 023	1.922	1 liter



MSA 2 MULTI Automatic Electrofusion Unit for PE/PP/PVDF/PB

The MSA 2 MULTI automatic electro fusion unit combines light weight and high efficiency, thanks to its inverter technology. The unit is suitable for welding PE, PP, INSTAFLEX PB d1 1/2"-12" and PPro-Seal 1/2"-3".

It is robust, safe and ergonomic.

All is meant to simplify the job: the barcode scanner, for long distance reading, the cooling system to joint in series, the icon system, to keep the interaction between user and machine intuitive. The entire welding process is controlled and regulated with energy output compensation depending on ambient temperature and the indication of cooling time.

The unit has 500 protocols permanently stored in the internal memory. The user can copy the fusion reports in an USB stick to print them out in PDF format.

Scope of delivery includes: 1 pair of angle adapter clips 4.0 mm, operating instructions, START/STOP badge, USB memory stick and robust transport case

Technical Data:

- Operating temperature: -20°C to +50°C
- Main voltage and frequency: 230V (190V - 265V), 50-60Hz
- Fusion data input mode: bar code, manual
- Fittings range: d16-630 mm , 1/2"-12"
- Fusion voltage: 3.6-40 V
- Fusion current: 90 A (max)
- Suggested power generators: 3.5 kVA
- USB Port: Type A
- Protection factor: Class 1 / IP 65
- Main cable: 4m / Fusion cable 3m
- Weight: ca. 26.2 lbs (11.9 kg)
- Display: Graphical LCD, adjustable contrast

	Type	Code	weight (lb)
Full package plus mini Welding Book		790 156 021	26.235
Full package plus mini Welding Book, SeaDrain adapters and barcodes		790 156 022	26.235



MSA Fusion to SeaDrain White Adapter Cables

Replacement MSA fusion cables 5 feet long.

Code	weight (lb)	Description
799 350 910	0.882	Single Cable
799 350 911	1.764	Cable Assembly

Fusion Machine Accessories

Code	weight (lb)	Description
799 350 901	0.441	Continuity Tester
799 350 902	0.220	Operation Mode Cards MSA250 EX Multi
799 350 904	0.661	SeaDrain White Barcode Set with Continuity Tester

11 Part Number Index

Code	Page	Code	Page	Code	Page	Code	Page
378 160 001	30	378 163 503	13	378 170 003	3	37D161539	10
378 160 002	30	378 163 504	13	378 170 004	3	37D161601	9
378 160 003	30	378 163 525	13	378 170 025	3	37D161603	9
378 160 004	30	378 164 001	5	378 170 230	15	37D161604	9
378 160 025	30	378 164 002	5	378 170 232	15	37D161625	9
378 161 501	9	378 164 003	5	378 170 234	15	37D161627	10
378 161 502	9	378 164 004	5	378 170 235	15	37D161628	10
378 161 503	9	378 164 025	5	378 170 801	16	37D161629	10
378 161 504	9	378 164 501	6	378 170 802	16	37D161631	10
378 161 530	10	378 164 502	6	378 170 803	16	37D161633	10
378 161 531	10	378 164 503	6	378 170 804	16	37D161635	10
378 161 532	10	378 164 504	6	378 170 825	16	37D161701	11
378 161 534	10	378 164 525	6	378 171 021	14	37D161728	11
378 161 535	10	378 164 601	4	378 171 027	14	37D161733	11
378 161 601	9	378 164 602	4	378 171 028	14	37D162201	24
378 161 603	9	378 164 603	4	378 171 029	14	37D162228	24
378 161 604	9	378 164 604	4	378 171 030	14	37D162301	25
378 161 625	9	378 164 625	4	378 171 031	14	37D162328	25
378 161 627	10	378 165 001	5	378 171 032	14	37D162401	26
378 161 628	10	378 165 002	5	378 171 033	14	37D162428	26
378 161 629	10	378 165 003	5	378 171 034	14	37D162601	8
378 161 631	10	378 165 004	5	378 171 035	14	37D162602	8
378 161 633	10	378 165 025	5	378 172 001	23	37D162701	7
378 161 635	10	378 167 301	21	378 172 002	23	37D162702	7
378 161 701	11	378 167 302	21	378 172 003	23	37D162703	7
378 161 728	11	378 167 303	21	378 172 004	23	37D162704	7
378 161 733	11	378 167 304	21	378 172 025	23	37D162801	29
378 162 201	24	378 167 325	21	378 172 101	23	37D162802	29
378 162 228	24	378 168 101	18	378 182 501	6	37D162803	29
378 162 301	25	378 168 102	18	378 182 502	6	37D162804	29
378 162 328	25	378 168 122	18	378 182 503	6	37D162806	29
378 162 401	26	378 168 123	18	378 182 504	6	37D162825	29
378 162 428	26	378 168 130	18	378 182 525	6	37D162901	7
378 162 601	8	378 168 701	17	378 187 530	15	37D162925	7
378 162 602	8	378 168 702	17	378 187 531	15	37D163001	11
378 162 701	7	378 168 703	17	378 187 532	15	37D163002	11
378 162 702	7	378 168 704	17	378 187 534	15	37D163003	11
378 162 703	7	378 168 722	17	378 187 535	15	37D163004	11
378 162 704	7	378 168 723	17	37A160601	29	37D163006	11
378 162 901	7	378 168 730	17	37A160602	29	37D163030	12
378 162 925	7	378 168 801	18	37A160603	29	37D163031	12
378 163 001	11	378 168 802	18	37A160604	29	37D163032	12
378 163 002	11	378 168 822	18	37A160625	29	37D163034	12
378 163 003	11	378 168 823	18	37D013015	2	37D163035	12
378 163 004	11	378 168 830	18	37D013020	2	37D163037	12
378 163 006	11	378 168 901	17	37D013025	2	37D163038	12
378 163 030	12	378 168 902	17	37D013030	2	37D163039	12
378 163 031	12	378 168 903	17	37D013040	2	37D163101	12
378 163 032	12	378 168 904	17	37D013060	2	37D163103	12
378 163 034	12	378 168 922	17	37D023015	2	37D163104	12
378 163 035	12	378 168 923	17	37D023020	2	37D163106	12
378 163 101	12	378 168 930	17	37D023025	2	37D163125	12
378 163 103	12	378 169 301	21	37D023030	2	37D163127	13
378 163 104	12	378 169 302	21	37D023040	2	37D163128	13
378 163 125	12	378 169 303	21	37D023060	2	37D163129	13
378 163 127	13	378 169 304	21	37D161501	9	37D163131	13
378 163 128	13	378 169 325	21	37D161502	9	37D163133	13
378 163 129	13	378 169 601	4	37D161503	9	37D163135	13
378 163 131	13	378 169 602	4	37D161504	9	37D163139	13
378 163 133	13	378 169 603	4	37D161530	10	37D163501	13
378 163 135	13	378 169 604	4	37D161531	10	37D163502	13
378 163 501	13	378 169 625	4	37D161532	10	37D163503	13
378 163 502	13	378 170 001	3	37D161534	10	37D163504	13
		378 170 002	3	37D161535	10	37D163525	13

Code	Page	Code	Page	Code	Page
37D164001	5	37D170001	3	37D182504	6
37D164002	5	37D170002	3	37D182506	6
37D164003	5	37D170003	3	37D182525	6
37D164004	5	37D170004	3	37D187530	15
37D164006	5	37D170006	3	37D187531	15
37D164025	5	37D170025	3	37D187532	15
37D164501	6	37D170230	15	37D187534	15
37D164502	6	37D170232	15	37D187535	15
37D164503	6	37D170234	15	37D187539	15
37D164504	6	37D170235	15	37D187610	19
37D164506	6	37D170401	3	37D187615	19
37D164525	6	37D170402	3	37D187640	19
37D164601	4	37D170403	3	37D187665	19
37D164602	4	37D170404	3	37D188800	20
37D164603	4	37D170406	3	37D188810	20
37D164604	4	37D170425	3	37D188820	20
37D164625	4	37D170501	22	37D188830	20
37D165001	5	37D170502	22	37D188840	20
37D165002	5	37D170503	22	37D188860	20
37D165003	5	37D170504	22	37D188870	20
37D165004	5	37D170506	22	37D188901	19
37D165006	5	37D170525	22	37D188902	19
37D165025	5	37D170801	16	37D188925	19
37D167301	21	37D170802	16	37X004817	29
37D167302	21	37D170803	16	37X004818	29
37D167303	21	37D170804	16	37X004832	31
37D167304	21	37D170806	16	37Z000090	30
37D167306	21	37D170825	16	37Z000091	30
37D167325	21	37D171021	14	37Z000092	30
37D168101	18	37D171026	14	37Z000096	30
37D168102	18	37D171027	14	37Z000097	31
37D168122	18	37D171028	14	37Z000400	30
37D168123	18	37D171029	14	37Z000600	30
37D168130	18	37D171030	14	37Z002150	28
37D168701	17	37D171031	14	37Z003390	28
37D168702	17	37D171032	14	37Z003404	28
37D168703	17	37D171033	14	37Z004844	28
37D168704	17	37D171034	14	790 156 021	32
37D168722	17	37D171035	14	790 156 022	32
37D168723	17	37D171036	14	790 205 072	31
37D168730	17	37D171037	14	790 309 003	31
37D168801	18	37D171038	14	799 298 023	31
37D168802	18	37D171039	14	799 350 901	32
37D168822	18	37D172001	23	799 350 902	32
37D168823	18	37D172002	23	799 350 904	32
37D168830	18	37D172003	23	799 350 910	32
37D168901	17	37D172004	23	799 350 911	32
37D168902	17	37D172025	23		
37D168903	17	37D172101	23		
37D168904	17	37D177001	22		
37D168922	17	37D177002	22		
37D168923	17	37D177003	22		
37D168930	17	37D177004	22		
37D169301	21	37D177006	22		
37D169302	21	37D177025	22		
37D169303	21	37D181101	27		
37D169304	21	37D181125	27		
37D169306	21	37D181301	27		
37D169325	21	37D181325	27		
37D169601	4	37D181401	28		
37D169602	4	37D181425	28		
37D169603	4	37D182501	6		
37D169604	4	37D182502	6		
37D169625	4	37D182503	6		

General Properties

Content

1	Overview of the SeaDrain® White Piping System	37
1.1	SeaDrain White - Sch40 PPFR	37
1.2	Coloring, Marking and UV Protection	37
1.3	Mechanical Properties	38
1.4	Chemical, Weathering and Abrasion Resistance	38
1.5	Thermal Properties	38
1.6	Combustion Behavior	38
1.7	Fire Load	38
1.8	Electrical Properties	39
1.9	Electrofusion Jointing	39
1.10	SeaDrain Fast-Lock® Mechanical Jointing	39
1.11	Cold Weather Installations	39
1.12	Benefits with Respect to Metallic Piping	40
1.13	Installation Costs	40
1.14	Weight	40
2	GF Piping Systems Quality Control	41
2.1	Raw Material Qualification Steps	41
2.2	In-Process Manufacturing Steps	41
3	Material Data: Physical Properties	42
3.1	Mechanical	42
3.2	Thermodynamics	42
3.3	Other	42

Overview of Symbols

Symbols of Properties



Chemical, Weathering and Abrasion Resistance



Cold Weather Installations



Coloring, Marking and UV Protection







Combustion Behavior



Electrical Properties



Mechanical Properties

Note	Designation	Explanation
	GF recommendation	This symbol is used when GF provides a general recommendation. The implementation of such general GF recommendations requires the involvement of a person skilled in the individual case.
	General Information	This symbol highlights information of particular importance.
	Warning sign (Damage to property)	This warning symbol is used to warn of a hazard that can damage tools, products or objects, e.g. caused by improper use of a tool or incorrect working method during assembly.
	Warning sign (Personal injury)	This warning symbol is used to warn of a hazard that may result in personal injury, e.g. caused by improper use of a tool or incorrect working method during assembly.

1 Overview of the SeaDrain® White Piping System

1.1 SeaDrain White - Sch40 PPFR

SeaDrain White is a complete corrosion free drainage system with excellent physical properties suitable for black and gray water systems. This makes it the ideal system for handling black and gray water waste and deck drainage applications present in today's marine vessels.

The system is ideal for use with onboard chemical cleaning agents as well as in galleys and food prep areas when used with USPH approved transitions and electrofusion jointing. Its inherent flexibility allows it to move naturally with the ship while removing encrustation and buildup.

The bright white coloring and UV resistant properties of the polypropylene compound reduce discoloration, allowing SeaDrain White to be used in customer facing areas during system service life.

- SeaDrain White fittings utilize a fusion collar with integrated duplex plugs on all fitting sockets 1½”–6”. The collar is fully rotatable (360°) to allow for positioning of plugs where they can be easily accessed by the installer.
- Plastic clamps are factory installed on 1½”–4” collars. A loose metal clamp for 6” allows for dry-fitting of entire sections prior to fusing.
- The system may be installed utilizing either a permanent fusion collar or the SeaDrain Fast-Lock® mechanical jointing method. While it has been manufacturer tested up to 87 psi (6 bar), the Fast-Lock jointing method can maintain a 58 psi (4 bar) @ 72°F (23°C) short-term safety pressure. The system has also been laboratory tested at 14.5 psi (1 bar) 24hr continuous pressure.

1.2 Coloring, Marking and UV Protection

Due to the limited ability to paint polyolefin thermoplastics, SeaDrain White has been released as a completely white system. This allows for use in customer facing areas and outside locations where other piping systems would normally require a "white" coating.

In line with the requirements of IACS, the pipe is permanently marked with required data by laser etching and does not require ink to be removed for aesthetic purposes.

For long-term color hold, a UV additive has been added to SeaDrain White allowing for outdoor use in direct and indirect sunlight.

SeaDrain White has been developed and tested for use under extreme UV conditions. Through the use of industry standard Accelerated Weather Tests (*ASTM G155 and **ASTM D5894), GF has been able to verify the capabilities of SeaDrain White as a suitable system for outdoor marine use. While 1000hr or greater laboratory weathering tests provide a strong indication of a materials overall performance, GF is performing a 1-year outdoor study to provide a comparative time frame. When tested and compared to a historical product with a long history in the market; in this case Fuseal PPFR (blue piping), it's much easier to understand the performance gains of an enhanced product such as SeaDrain White.

The following table compares the average results of the two UV test protocols (of ASTM G155 and ASTM D5894) for SeaDrain White PP (with UV protection), Non-UV White PP, and Fuseal PPFR Blue (Baseline).

TII.1 Comparison of UV Test Results

Description	Values for UV White PP	Values for Non-UV White PP	Values for UV Fuseal PP
Percent Exterior Change (Glossiness)	3%	46%	92%
Percent Color Change (Discoloration)	0.07%	0.10%	7%
Percent Change in Tensile Strength	2%	3%	3%

*ASTM G155: Xenon-Arc Exposure of Plastics Intended for Outdoor Application

**ASTM D5894: Cyclic Salt Fog/UV Exposure (Alternating Exposures in a Fog/Dry Cabinet and a UV/Condensation Cabinet)



1.3 Mechanical Properties

Polypropylene has a high tensile strength and stiffness, preventing excessive sag and allowing for greater distance between supports. Polypropylene has a very good long-term creep strength at higher temperatures, for example, 180°F (82°C), at continuous stress.



1.4 Chemical, Weathering and Abrasion Resistance

The SeaDrain White system is resistant to the corrosive action of alkalis, alcohols, acids, solvents and salt solutions. Dilute mineral acids and aqueous solutions of acid salts, which are destructive to most metals, have no effect on the polypropylene piping systems. In general, polypropylene is attacked only by strong oxidizing acids and weakened by certain organic solvents and chlorinated hydrocarbons. Polypropylene will not rust, pit, scale, corrode or be affected by electrolysis.



SeaDrain White gaskets and seals all meet the same stringent application and quality standards.

When installed outdoors, the UV additive protects SeaDrain White from sunlight. The additive is highly resistant to ultraviolet radiation and is heat-stabilized to provide long life while handling hot reagents.

1.5 Thermal Properties

The SeaDrain White polypropylene compound yields a combination of high chemical resistance, toughness and high strength at elevated temperatures.

The thermal conductivity of PP is 1.3 BTU-in/ft²/hr/°F (0.19 W/mK). In certain applications, PP's inherent thermal insulating properties will act as an insulator and prevent the formation of condensation on the external surface of the pipe. In these instances, there are notably more economical advantages when compared to a system made of metals, such as stainless steel and copper.

III.2 Comparison of Common Piping Materials

Material	BTU-in/ft ² /hr/°F	W/mK
PP	1.3	0.19
Glass	8.0	1.15
Stainless Steel	97.3	14.0
Aluminum	1,000.0	144.1
Copper	2,700.0	389.2

The SeaDrain White polypropylene piping system handles aggressive drainage fluids up to 212°F (100°C) intermittently.

1.6 Combustion Behavior

Polypropylene is a flammable plastic. The oxygen index amounts to 19 %. With an oxygen index below 21 %, a plastic material is considered to be flammable. The specialized nature of SeaDrain White allows it to achieve a low burn rate per ASTM D635 and subsequent PFR quality. Toxic substances are released by all burning processes, while carbon monoxide is generally the most heavily released combustion product that can be dangerous to humans.



1.7 Fire Load

III.3 Fire Load Values of SeaDrain White

Pipe Size (IPS)	Pipe Size (DN)	BTU/ft	kWh/m
1½"	40	12,540	12.06
2"	50	16,720	16.08
2½"	65	26,600	25.58
3"	80	34,580	33.25
4"	100	49,400	47.50
6"	150	86,640	83.31

1.8 Electrical Properties

Since polypropylene is a non-polar hydrocarbon polymer, it is an outstanding electrical insulator. The insulative properties, however, can be compromised considerably from the effects of oxidizing media or weathering as a result of pollution.

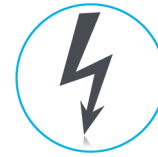

1.9 Electrofusion Jointing

Electrofusion jointing is an excellent jointing solution that provides numerous advantages. The process of assembling pipe to a fitting socket uses wires to transfer the heat energy to the plastic material. The heat energy is sufficient to melt the plastic surrounding the wires. This generates a zone called the "melt zone." This "melt zone" encapsulates the wires that are at its origin along the center line.

These features make this one of the safest and easiest fusion technologies on the market.

Advantages

- Faster fusion times than most competitive systems
- Fuse multiple joints in one heat cycle
- Automatically adjusts fusion cycle times based on environmental temperature levels through ATC (Automatic Temperature Compensation)
- Automatically adjusts fusion cycle times or automatic shutdown of fusion cycle based on power source fluctuations.
- Parallel wiring connections to fusion collars allow for a faster, more secure duplex plug connection than the series wiring configuration required by all competitive systems

i

SeaDrain White is compatible with Fuseal SeaDrain (Blue) and can be assembled by both Electrofusion or Fast-Lock jointing methods.

i

Material and fusion machines must be the same temperature prior to fusion. This can be achieved when components and machines are in the same environment for a minimum of 2 hours.

1.10 SeaDrain Fast-Lock® Mechanical Jointing

Mechanical jointing makes fast, leak-proof joints in two easy steps: insert the pipe into the gasketed socket and tighten the 8mm or 10mm head screw (depending on the size of the joint). The system is immediately ready for leak-free service.

This simple method of jointing utilizes a cutter, chamfering tool and either an 8mm or 10mm socket wrench. GF also has an optional torque kit available for quality checks.

The lubricant used in the Fast-Lock system is a "Food Grade" silicone/moly based lubricant capable of being utilized in temperatures ranging from -40°F (-40°C) to 392°F (200°C). The lubricant contains no hazardous ingredients according to GHS.

TII.4 Fast-Lock Torque Requirements (Imperial)*

Pipe Size (IPS)	Pipe Size (DN)	Hex Socket (metric)	Minimum (in-lbs)	Maximum (in-lbs)
1½"IPS / 2"IPS / 2½"IPS	DN40/DN50/DN65	8	10.0	35.0
3"IPS / 4"IPS	DN80/DN100	10	49.0	75.0

TII.5 Fast-Lock Torque Requirements (Metric)

Pipe Size (IPS)	Pipe Size (DN)	Hex Socket (metric)	Minimum (Nm)	Maximum (Nm)
1½"IPS / 2"IPS / 2½"IPS	DN40/DN50/DN65	8	1.13	3.95
3"IPS / 4"IPS	DN80/DN100	10	5.54	8.47

*This data is for reference only. SeaDrain Fast-Lock should only be installed by trained and certified personnel.



1.11 Cold Weather Installations

In general, it is good practice when possible, to maintain an ambient temperature above 40°F (4°C). However, low temperature fusions to 14°F (-10°C) are easily accomplished utilizing the automatic temperature compensation capabilities of the MSA and Electro Plus® fusion machines from GF.

1.12 Benefits with Respect to Metallic Piping

There are many benefits to using thermoplastics over traditional metal piping in non-essential systems, including corrosion resistance, reduced cost, and reduced weight. The following sections highlight some of the major benefits.

Corrosion

Metallic piping systems are subject to the following types of damage:

- Rusting – The formation of iron oxide on iron or steel by oxidation, especially in the presence of moisture.
- Scaling – A coating of oxide formed on heated metal.
- Pitting – Localized corrosion confined to a point or small area that takes the form of cavities.
- Corrosion – Deterioration due to oxides that flake away from the base metal.
- Electrolysis – The process in which a metallic surface is continuously corroded by another metal with which it comes in contact.

The application temperatures for semi-crystalline and amorphous thermoplastics vary due to their different properties. Semi-crystalline materials are preferably used at temperatures above their glass transition temperature. However, amorphous thermoplastics are used below the glass transition point. Plastics also tend to creep to progressive deformation under load. Their mechanical properties are not only temperature-dependent, but also time-dependent. For use in piping system construction, the materials are therefore tested for their creep internal compressive strength in accordance with [ISO 1167](#) and [ISO 9080](#) in order to determine the maximum operating temperature and pressure for a service life of 50 years.

The characteristic values for mechanical properties of GF pipe materials can be found in the relevant raw materials chapter.

Thermoplastics will not rust, scale, pit, or corrode, nor are they subject to electrolysis. Metallic piping will quickly corrode in many marine applications. You are assured many years of leak-free, maintenance-free service with GF Piping Systems thermoplastics.

1.13 Installation Costs

Generally speaking, SeaDrain White's installed cost is substantially lower than metallic and alternative plastic piping systems. Material costs are competitive with metal, however a significant reduction in the number of pipe installation hangers needed, lowers the overall cost below that of metal and alternative plastics. The lighter weight of SeaDrain White speeds installation and simplifies handling. The SeaDrain Fast-Lock and Electrofusion jointing methods help to contribute to a lower installed cost.

1.14 Weight

SeaDrain is lightweight and easily transported during installation. The table below shows the density comparison between SeaDrain White and commonly used metal pipes. Weight is an important factor in marine vessels, and the weight savings in doing an entire system in thermoplastics is significant.

TII.6 Densities of Various Materials

Material	Density (lb/ft ³)	Density (g/cm ³)
SeaDrain	59	0.95
Copper	556	8.91
Steel	503	8.06
Stainless Steel	491	7.87

2 GF Piping Systems Quality Control

GF Piping Systems has always been known for providing the highest quality products and there is no difference when it comes to the manufacturing of our SeaDrain marine drainage system. While other manufacturers may consider these applications as non-essential, we consider them highly engineered, critical systems that must operate in a demanding environment with a zero-leak tolerance. This makes them no different from the many other thermoplastic piping systems we manufacture. Our rigorous attention to detail, material qualification, raw material testing, and in-process quality assurance are essential steps that we apply to maintain these same consistently high standards of quality you've come to expect from GF Piping Systems.

It starts with the right choice of raw materials, choosing the best suppliers, and verifying that each and every shipment received meets our high standards. We insist on strict quality control throughout the entire manufacturing process to make sure our products not only meet or exceed our stringent specifications, but also provide trouble-free installation and years of service. Finally, we take extra care in packaging and protecting the products before they leave our plant. You can expect the product to arrive at the job site in the same excellent condition as when it left our plant.

2.1 Raw Material Qualification Steps

Before any raw material can be processed, batches are checked for density and moisture content. They are then separated by batch number to ensure there is no possibility of unintended blending of raw materials. In addition, raw material is compared to control samples. Inconsistent pellet size, pellet geometry, and contamination are cause for material rejection.

Once preliminary checks are complete, the resin is checked with a Brabender or torque rheometer that simulates the way the material will behave when processed through molding machines and extruders. If raw material is out of specification, it will be rejected at this time.

Next, the resin is heated and pressed to flatten the material to under 1/10 in (2.5 mm) with several tons of pressure. This is used to check for correct color using a color platen. It is then analyzed using the color spectrometer. If the material's color is out of tolerance and does not meet specification, the material is rejected.

After color check, the melt flow indexer is used to measure the viscosity of the material and how it will behave in the molding and extrusion processes. If the material passes this final step, it can then be released to production.

Each batch of raw material is retained for five years. This provides traceability in case of a post-manufacturing material issue. Markings on a fitting or pipe allow traceability back to each batch of raw material used in production.

Samples of finished product are also retained on a regular basis. As with the raw material, if a problem is suspected, it can be compared to the retained sample to help confirm visual and dimensional conformance. Traceability is an integral part of the quality process.

2.2 In-Process Manufacturing Steps

A coordinate measurement machine (CMM) is an extremely precise measuring device that is used to qualify dimensional tolerances on finished products. In many cases, the GF Piping Systems specifications are tighter than ASTM specifications. When making electrofusion or mechanical joints, a proper fit-up between pipe and fitting is important to ensure leak-proof connections. Too big of a gap can result in weak joints and possible premature failure.

Fittings are routinely pressure tested to failure. This process helps understand safety factors and ensures that the fitting meets or exceeds ASTM standards.

All manufacturing processes are constantly monitored, recorded, and analyzed to make sure products are produced to the most exacting specifications.

3 Material Data: Physical Properties

TII.7 Typical physical properties for SeaDrain White PPR thermoplastic materials in Imperial and Metric units

3.1 Mechanical

Properties	Unit (Metric)	SeaDrain White (Imperial)	SeaDrain White (Metric)	ASTM Test
Density	lb/in ³ (g/cm ³)	0.034 ± 0.0007	0.94	D-792
Tensile Strength @ 73°F (23°C)	psi (MPa)	4,500	31	D-638
Elastic Modulus @ 73°F (23°C)	psi (MPa)	188,550	1300	D-790
Izod Impact @ 73°F (23°C)	ft-lbs/in of Notch (kJ/m ²)	0.8	4	D-256
Relative Hardness @ 73°F (23°C)	Rockwell "D"	72	72	D-2240

3.2 Thermodynamics

Properties	Unit (Metric)	SeaDrain White (Imperial)	SeaDrain White (Metric)	ASTM Test
Coefficient of Thermal Linear Expansion	in/in°F (mm/mK)	6.1 × 10 ⁻⁵	0.11 × 10 ⁻⁴	D-696
Thermal Conductivity	BTU-in/hr-ft ² -°F (W/mK)	1.3	0.19	C-177
Minimum Operating Temperature	°F (°C)	23	-5	GF Specified
Maximum Operating Temperature	°F (°C)	212	100	GF Specified
Heat Deflection Temperature @ 66 psi (18 bar)	°F (°C)	210	99	D-648

3.3 Other

Properties	Unit (Metric)	SeaDrain White (Imperial)	SeaDrain White (Metric)	ASTM Test
Water Absorption	%	<0.03 @ 77°F	<0.03 @ 25°C	D-570
Industry Color		White	White	D-1784
Color Code	RAL	120-2	120-2	GF Specified
Burning Rate	in/min (mm/min)	0.81 (HB)	20.62 (HB)	ASTM D635-18
Fire Load	BTU/lb (MJ/kg)	38,000	88.39	GF Specified

Note: This data is based on information compiled from multiple sources.

Design and Engineering

Content

1.1	Pipe Design	45
1.2	Determining Pressure-Stress of Pipe.....	45
2	Gray (Gravity) Water Service	46
2.1	Calculating for Gravity Drain Systems.....	46
3	Black (Vacuum) Water Service	48
3.1	Overview.....	48
3.2	Vacuum Line Sizing Guidelines	48
3.3	Negative Pressures	48
3.4	Bracketing	50
3.5	Optimal Design	50
3.6	Pipe Profile and Transport Pockets.....	50
3.7	Branches	51
3.8	Riser Pipes for Toilets.....	52
3.9	Inspection/Clean-out Plugs	53
3.10	Vacuum Piping Test Procedure	53
3.11	Vacuum Test Reporting Sheet	54



Public Spaces

Black Water
Gray Water
Central Vacuum

Cabins

Black Water
Gray Water
Central Vacuum

Food Prep

Gray Water (USPH)
Up to 212°F (100°C)
Intermittent

Laundry

Gray Water
Up to 212°F (100°C)
Intermittent

Deck Drains

Deck Water
Outside
(Customer Facing)

Easy to install

With a single tool, SeaDrain Fast-Lock® is quick and easy to install for line sizes 4" (DN100) and below. Automated electrofusion is available in all sizes 1½" (DN40) to 6" (DN150).

UV-resistant, no paint needed

SeaDrain® White's bright white external coloring includes additives for UV resistance against discoloration, negating the need for external paint.

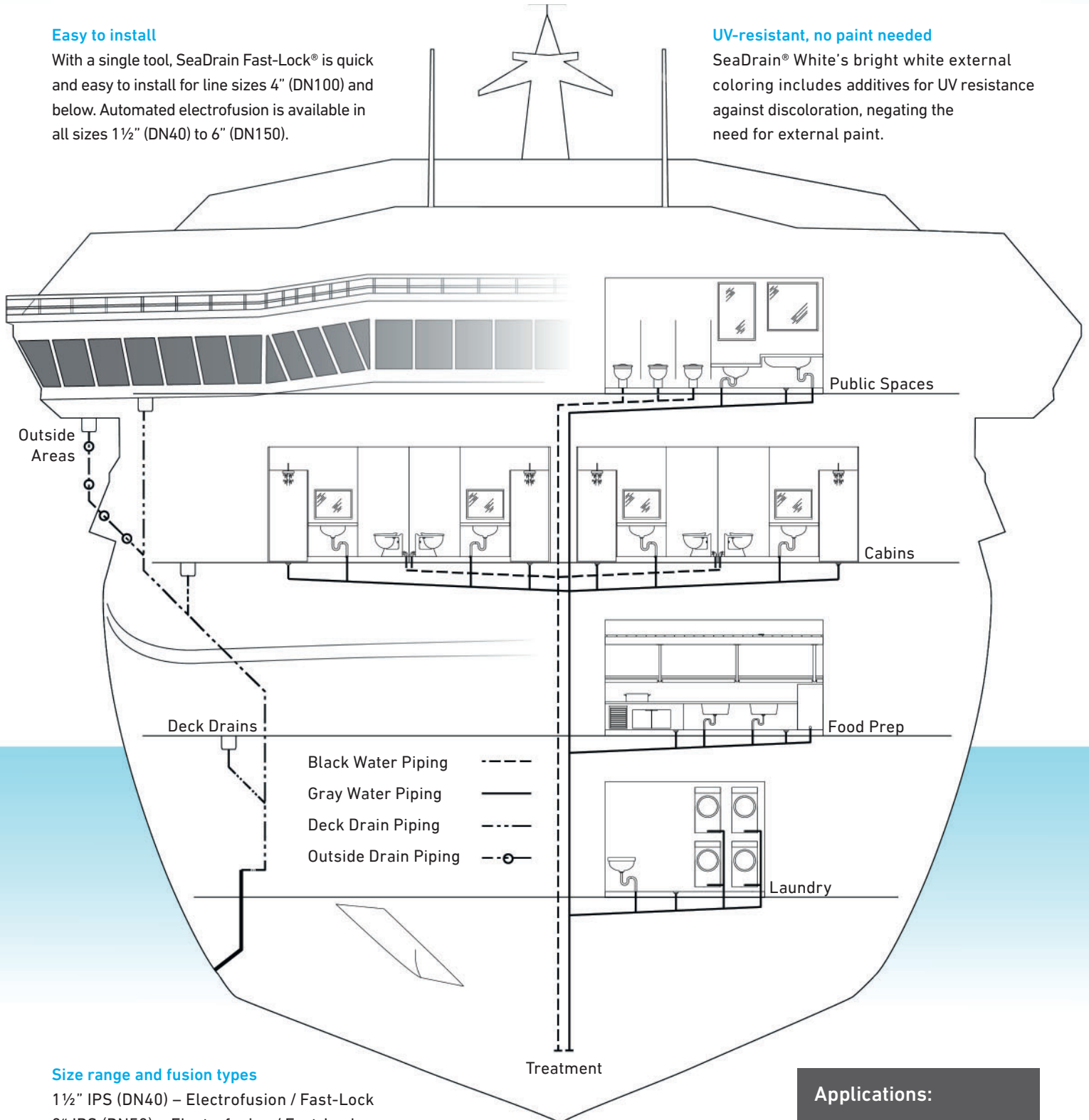

Size range and fusion types

- 1½" IPS (DN40) – Electrofusion / Fast-Lock
- 2" IPS (DN50) – Electrofusion / Fast-Lock
- 2½" IPS (DN65) – Electrofusion / Fast-Lock
- 3" IPS (DN80) – Electrofusion / Fast-Lock
- 4" IPS (DN100) – Electrofusion / Fast-Lock
- 6" IPS (DN150) – Electrofusion

Applications:

Vacuum:
-29.0psi (-2.0bar)

Gravity:
58 psi (4.0 bar) (max.)

1 Piping System Engineering

1.1 Pipe Design

In the engineering of thermoplastic piping systems, it is necessary to have not only a working knowledge of piping design, but an awareness of the unique properties of thermoplastics.

In addition to chemical resistance, important factors to be considered in designing piping systems employing thermoplastics are:

- Pressure ratings
- Gray Water Gravity Service
- Black Water Vacuum Service
- Central Vacuum Cleaner Service
- Vent Line Applications
- Thermal expansion and contraction
- Proper Pipe Restraint

The following sections detail the basic theory and equations associated with each of these factors. Note that unless otherwise specified, all calculations assume an infinitely long pipe, and if a short pipe is being used the calculations may be significantly different. A short pipe varies in definition, but a good rule of thumb is L/D should be greater than 10-50 where L is the length of pipe and D is the outer diameter.

TIll.3 SeaDrain White Pipe Dimensions

Pipe Size (IPS)	Pipe Size (DN)	OD (inch)	Wall (inch)	ID (inch)	OD (mm)	Wall (mm)	ID (mm)
1½"	40	1.900	0.145	1.610	48.3	3.7	40.9
2"	50	2.375	0.154	2.067	60.3	3.9	52.5
2½"	65	2.875	0.203	2.469	73.0	5.2	62.7
3"	80	3.500	0.216	3.068	88.9	5.5	77.9
4"	100	4.500	0.237	4.026	114.3	6.0	102.3
6"	150	6.625	0.280	6.065	168.3	7.1	154.1

1.2 Determining Pressure-Stress of Pipe

SeaDrain White is an engineered gravity/vacuum drain piping system. However, it is engineered with a 14.5 psi (1.0 bar) nominal pressure @ 73°F (23°C). This nominal pressure takes into account that SeaDrain marine drainage piping has a short-term burst pressure rating of 58 psi (4 bar) and a long-term burst pressure rating of 36 psi (2.5 bar). For black water vacuum service SeaDrain White has been tested to ASTM D2924, as seen in the following table:

TIll.4 External Pressure Test - ASTM D2924

Pipe Size (IPS)	Pipe Size (DN)	Avg. OD (inch)	Minimum Wall (inch)	Avg. Collapse (psig)	Avg. OD (mm)	Minimum Wall (mm)	Avg. Collapse (bar)
1½"	40	1.900	0.145	418	48.3	3.7	28.8
4"	100	4.500	0.237	134	114.3	6.0	9.24
6"	150	6.625	0.280	77	168.3	7.1	5.31

i

The equations in this section give a general idea as to the design of a piping system but do not substitute for the judgement of a licensed engineer.

III

!

Collapse pressure calculations are for static external pressures only. Dynamic factors are not taken into account and may cause additional stresses.

2 Gray (Gravity) Water Service

2.1 Calculating for Gravity Drain Systems

Drainage flow is caused by gravity due to the slope of all drainage piping. Drainage piping is deliberately designed to run only partially full; a full pipe, particularly a stack, could blow out or suck out all the trap seals in the system. For a given type of pipe (friction), the variables in drainage flow are slope and depth of liquid. When these two factors are known, the flow rate Q and flow velocity V can be calculated.

The Manning coefficient for surface roughness used in the following equations are constants. The following table shows a comparison of SeaDrain to metals.

Manning Coefficients

Material	n
SeaDrain White	0.009
Copper	0.011
Steel	0.012

Formula for calculating discharge flow rates and velocities

$$Q = A \times (1.486 / n) \times R^{2/3} \times S^{1/2}$$

$$V = (1.486 / n) \times R^{2/3} \times (S^{1/2} / 12)$$

Symbol	Meaning	Value	Unit	Remark
Q	Flow Rate		[gpm]	
A	Section Area Pipe		[ft ²]	
n	Manning Friction Factor	0.009		product/material specific
R	Hydraulic Radius of Pipe ID/4		[ft]	
S	Hydraulic Gradient - Slope		[in/ft]	

Sample Flow Rate

What is the Flow Rate and velocity of water in a half-filled 3" SeaDrain Pipe with a slope of 1/4 in/ft Slope?

SeaDrain White: 3" (DN80)

Outer Diameter: 3.500 (in)

Inside Diameter: 3.068 (in)

Q - Flow Rate (gpm)

A - Section Area Pipe 0.0513 full = 0.0257 1/2 full (ft²)

n - Manning Friction Factor 0.009

R - Hydraulic Radius of pipe 0.0639 (ft)

S - Hydraulic Gradient - Slope 1/8 (in/ft) = 0.0104

Slope 1/4 (in/ft) = 0.0208

Slope 1/2 (in/ft) = 0.0416

$$Q = 0.0257 \times (1.486 / 0.009) \times 0.0639^{2/3} \times 0.0208^{1/2}$$

$$Q = 4.243 \times 0.160 \times 0.144$$

$$Q = 0.0976 \times 448.83 \text{ (conversion factor)}$$

$$Q = 43.85 \text{ (gpm)}$$

$$Q = 165.99 \text{ (lpm)}$$

Sample Velocity

$$V = (1.486 / 0.009) \times 0.0639^{2/3} \times (0.0208^{1/2} / 12)$$

$$V = 165.111 \times 0.160 \times 0.012$$

$$V = 0.317 \text{ (ft/s)}$$

$$V = 0.097 \text{ (m/s)}$$

TIII.5 Approximate Discharge Flow Rates and Velocities for Drains Flowing Half-Full

		SeaDrain White Schedule 40					
		¼ (in/ft) Slope		¼ (in/ft) Slope		½ (in/ft) Slope	
Pipe Size (IPS)	Pipe Size (DN)	Flow Rate (gpm)	Velocity (ft/s)	Flow Rate (gpm)	Velocity (ft/s)	Flow Rate (gpm)	Velocity (ft/s)
1½"	40	5.6	0.15	7.9	0.21	11.1	0.29
2"	50	10.8	0.17	15.3	0.24	21.6	0.34
2½"	65	17.4	0.19	24.6	0.27	34.8	0.39
3"	80	31.0	0.22	43.9	0.32	62.0	0.45
4"	100	64.0	0.27	90.5	0.38	128.0	0.54
6"	150	190.9	0.35	270.0	0.50	381.8	0.71

		SeaDrain White Schedule 40					
		10 (mm/m) Slope		21 (mm/m) Slope		42 (mm/m) Slope	
Pipe Size (IPS)	Pipe Size (DN)	Flow Rate (lpm)	Velocity (m/s)	Flow Rate (lpm)	Velocity (m/s)	Flow Rate (lpm)	Velocity (m/s)
1½"	40	21.2	0.05	29.9	0.06	42.0	0.09
2"	50	40.9	0.05	57.9	0.07	81.8	0.10
2½"	65	65.9	0.06	93.1	0.08	131.7	0.12
3"	80	117.3	0.07	166.2	0.10	234.7	0.14
4"	100	242.3	0.08	342.6	0.12	484.5	0.16
6"	150	722.6	0.11	1,022.1	0.15	1,445.3	0.22



3 Black (Vacuum) Water Service

3.1 Overview

In marine passenger vessels, sewage transport is done by vacuum (air) instead of water and gravity. Because of this vacuum condition, negative pressure and external pressures should be considered at all times.

System loading should be divided equally between main headers. The pitching and rolling of the vessel should be considered in horizontal runs to prevent sewage back-flow. It is recommended that horizontal runs be sloped and that transport pockets be located at 80ft to 100ft (24.4m to 30.5m) intervals. Piping shall be accessible and divided into sections for easy maintenance.

3.2 Vacuum Line Sizing Guidelines

TIII.6 Vacuum Pipe Size Requirements

Number of Vacuum Toilets in Cabins*		Public Toilets	Connection DN	SeaDrain Pipe Size
3	or	1	40	1½
25		5	50	2
100		25	65	2½

* It is recommended that the number of toilets not exceed 60 for easier maintenance.

- ▶ Pipe sizing is based on the assumption that 2 - 3 persons are using a cabin toilet per peak hour. For public toilets up to 15 flushes per hour is estimated.
- ▶ Heavily used public toilets are recommended to be attached as individual pipes into the pipe manifold.

3.3 Negative Pressures

Critical collapse pressure is the maximum allowable pressure that can be applied externally to a pipe and is directly related to the wall thickness and diameter of the pipe selected. Examples of when external pressure conditions can occur are as follows:

- Underwater applications
- Vacuum service

The actual external load being applied to the pipe is the difference between the external pressure and the internal pressure, which counteract each other. Thus, a pressurized pipe can withstand a greater external load than an empty pipe. As implied by the collapse rating, SeaDrain White pipe is suitable for vacuum pressure conditions as well. The process for determining maximum vacuum pressures are the same as for external pressures, as negative pressure inside the pipe is equivalent to positive pressure outside the pipe.

Formula for calculating critical collapse pressure applied uniformly to a long pipe

$$D_{avg} = OD - t_{min}$$

$$P_c = (1 / SF) \times ((2 \times E) / ((1 - \nu^2) \times (D_{avg} / t_{min})^3))$$

Symbol	Meaning	Value	Unit	Remark
P_c	Critical Collapse Pressure		[psi]	
E	Modulus of Elasticity		[MPa]	
ν	Poisson's Ratio	0.009		Material Specific
D_{avg}	Average Pipe Diameter		[in]	
t_{min}	Minimum wall thickness		[in]	
SF	Safety factor			

i The table (left) gives the calculated critical collapse pressure with no safety factor. For long term collapse pressures, values should be divided by a safety factor of 2 or 3.

Sample Critical Collapse 1.0 x Safety

What is the Critical Collapse Pressure for 2½" SeaDrain White Pipe?

SeaDrain White: 2½" (DN65)
 Outer Diameter: 2.875 (in)
 Wall Thickness: 0.203 (in)

E - 188,550 (psi)
 ν - 0.42
 OD - 2.875 (in)
 t_{min} - 0.203 (in)
 SF - 1.0

$$D_{avg} = 2.875 - 203$$

$$D_{avg} = 2.672 \text{ (in)}$$

$$P_c = (1 / 1.0) \times ((2 \times 188,550) / ((1 - 0.42^2) \times (2.672 / 0.203)^3))$$

$$P_c = (1 \times 377,100) / (0.824 \times 2,280.5)$$

$$P_c = 377,100 / 1,878.2$$

$$P_c = 201 \text{ (psi)}$$

$$P_c = 13.8 \text{ (bar)}$$

Sample Critical Collapse 3.0 x Safety

What is the Critical Collapse Pressure for 2½" SeaDrain White Pipe with a 3.0 x Safety Factor?

$$P_c = 201 \text{ (psi)} / 3 = 67 \text{ (psi)}$$

$$P_c = 13.8 \text{ (bar)} / 3 = 4.6 \text{ (bar)}$$

! Threaded connections are not recommended due to the greater potential for leakage when used in negative pressure applications.

Table 7 Short term collapse pressure for SeaDrain White Schedule 40 pipe at 73°F (23°C)

Pipe Size (IPS)	Pipe Size (DN)	P_c (psi)	P_c (bar)
1½	40	258	17.8
2	50	153	10.5
2½	65	201	13.8
3	80	130	9.0
4	100	79	5.4
6	150	39	2.7

3.4 Bracketing

In vacuum piping high "slug" speed temporarily creates strong forces at bends and branches. Pipes must be firmly secured by using brackets and clamps. For plastic pipes, use steel brackets with a resilient liner between bracket and pipe or plastic clamps. Ensure that pipes will not be damaged by vibration or thermal expansion / contraction. When connecting a riser pipe to an overhead main line, brackets or clamps must be secured both behind the toilet and to the deckhead. For straight plastic pipes, fit brackets at 6.5ft to 10ft (2m to 3m), depending on the line size (See pipe hanger installation section for details).

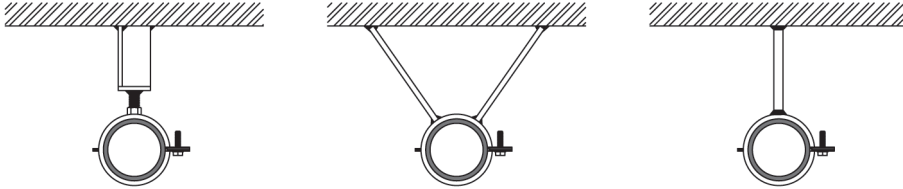

 Brackets must resist lateral forces

3.5 Optimal Design

Vacuum systems provide many benefits and flexibility because the system is not dependent on gravity.

Downward piping connections are beneficial for long term system operation and maintenance, however sanitary equipment (toilets and interface valves) can be connected to riser pipes.

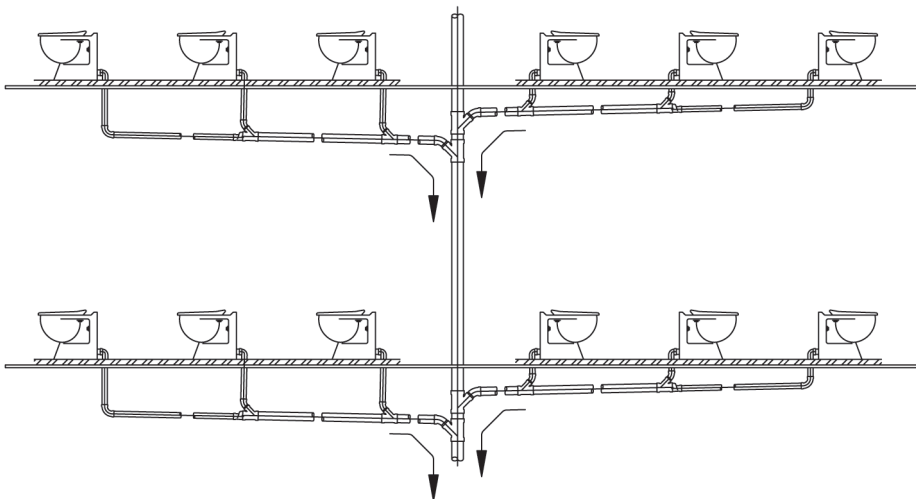

3.6 Pipe Profile and Transport Pockets

3.6.1 Optimal Slope and pocket

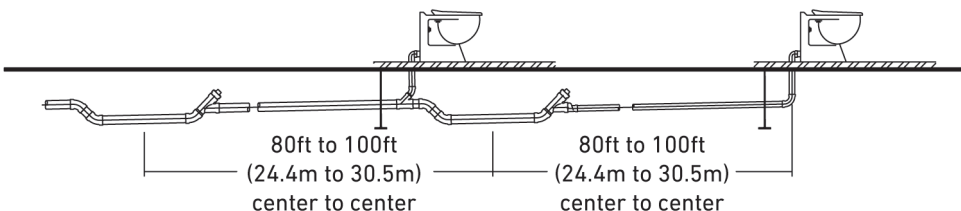

 Minimum Slope is 0.2%

3.6.2 Pockets in long horizontal branch and main lines

No need for reforming pocket

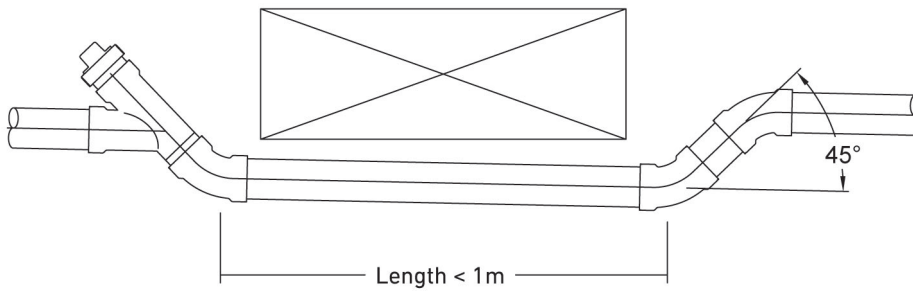

If a horizontal branch or main pipe has to route around an obstacle where pipe pocket length is less than 3.3ft (1m), no reforming pocket is needed.

Reforming pocket needed

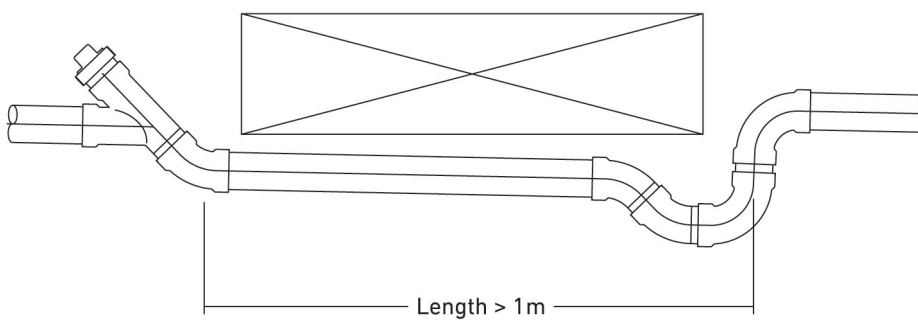

When pocket in branch or main pipe is greater than 3.3ft (1m) it is recommended to design and install a reforming pocket.

3.7 Branches

Branch pipes must be connected to the main line at an angle of 45° in the direction of downward the flow.

► Double-Y or T-branches should not be used.

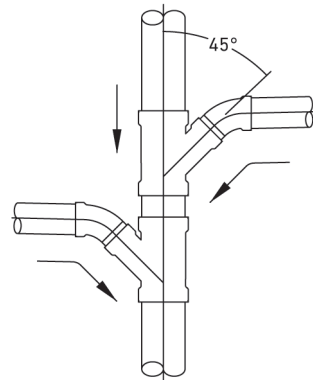

3.8 Riser Pipes for Toilets

Typical one deck height, 6.5ft to 10ft (2m to 3 m) riser pipe with a toilet or interface valve.

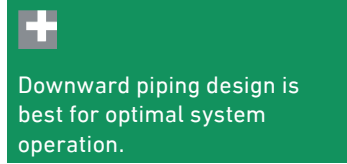
 Downward piping design is best for optimal system operation.

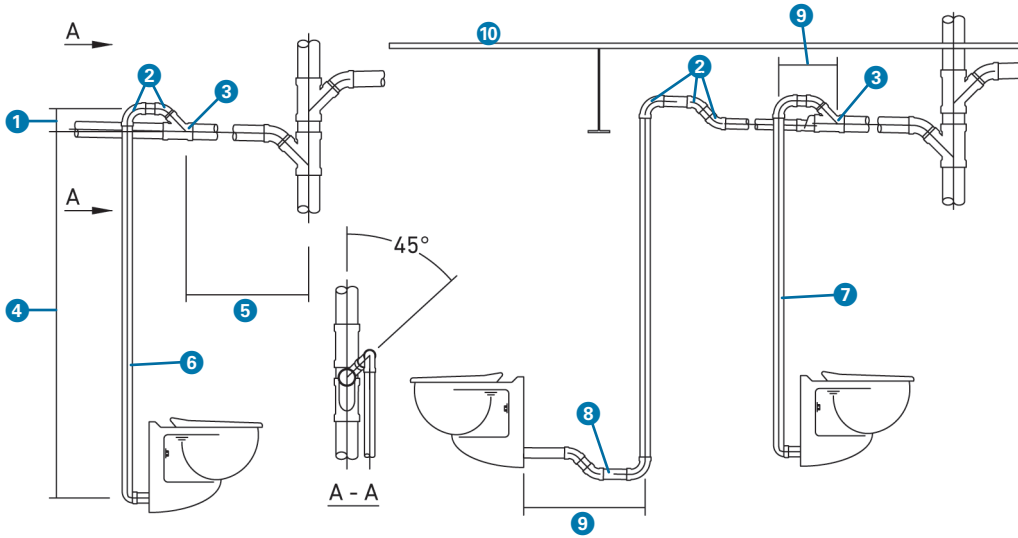

- 1 Connection from above should be greater than 3 times the riser pipe diameter
- 2 Smooth long radius bends or 2 x 45° pieces
- 3 45° connection to main pipe
- 4 Riser length - 6.5ft to 10ft (2m to 3m) maximum
- 5 Maximum pipe length is 30m to downward pipe
- 6 1½"IPS (DN40) riser pipe
- 7 Straight riser pipe without changes of direction
- 8 Transport pocket
- 9 Maximum length 5ft (1.5m)
- 10 Deck

Connections from above and below the deck should have separate horizontal branch pipes.

Each toilet should have its own riser pipe and the maximum distance between the downward pipe and end toilet riser pipe should be no greater than 100ft (30.5m).

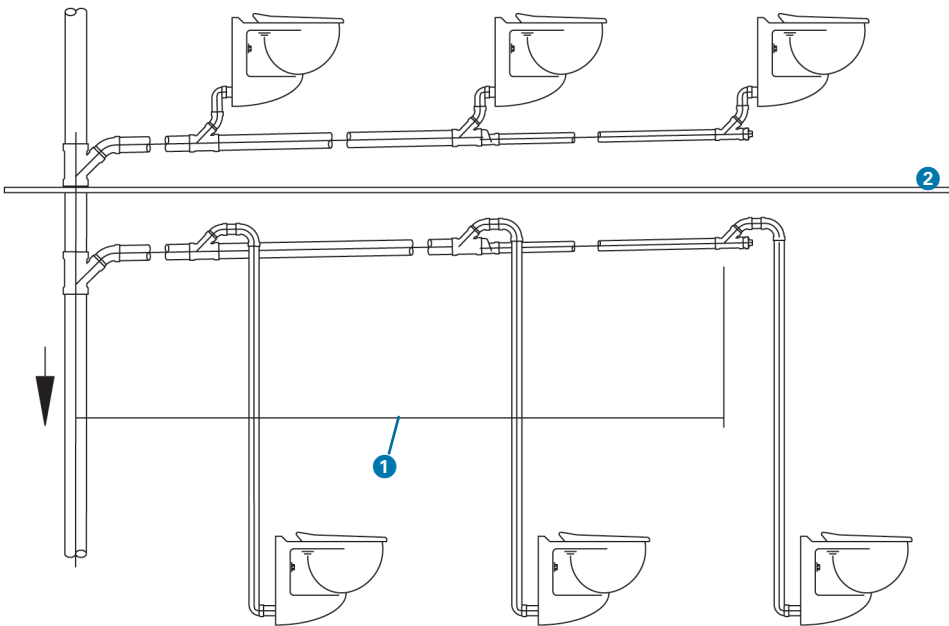

- 1 Maximum distance from downward pipe is 100ft (30.5m)
- 2 Deck

3.9 Inspection/Clean-out Plugs

Inspection openings should be located in such a way that a possible blockage in the piping can be reached at all points in the system. Recommended maximum distance between openings is up to 100ft (30.5m).

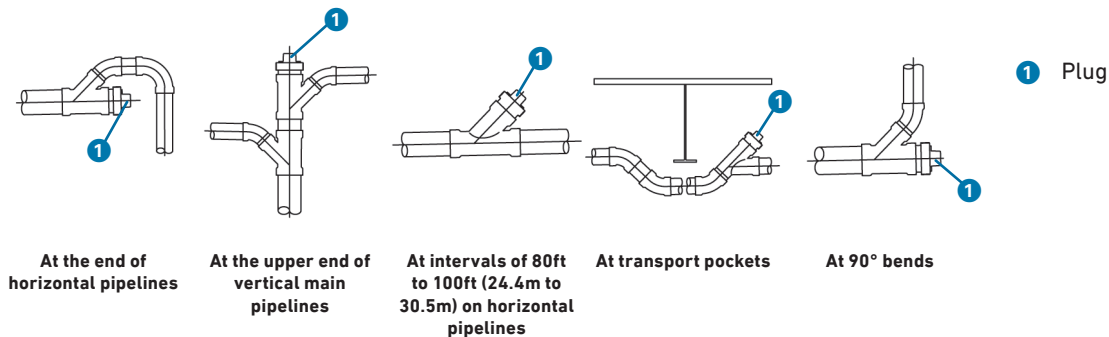

3.10 Vacuum Piping Test Procedure

3.10.1 Piping inspection and tightness

As sewage transportation is based on pressure difference, there should be minimum leakage in the vacuum sewage system. Leakage in the system will lower the systems overall performance and can increase wear and tear on secondary components. Additionally, electricity consumption can increase due to the pumps running more often to maintain vacuum. Low vacuum pressure decreases the sewage flow speed in pipes and can increase the chances of clogging and overall maintenance requirements.

Vacuum pipe layout and installation should be checked in individual sections during construction. Leak testing can be done by using water, or preferably, with a vacuum. Pipeline leak testing is to be done before installation of toilet equipment. Toilet connections should be blocked during the test by rubber plugs or equivalent means.

During pipe installation, leak tests shall be performed to eliminate possible leaks in the piping system. When the sewage piping system is ready with all vacuum components connected, the test should be run again to check for any possible leaks in the toilets, vacuum interface valves, etc.

3.10.2 Vacuum Testing

When a section of the piping system is completed, a vacuum leak test should be performed. All discharge lines are to be blanked (capped) off and a vacuum of -8.7psi (-0.60 bar) vacuum created in the piping lines. The vacuum after 1 hour can not be less than -8.5psi (-0.59 bar) or the piping section should be reworked and rechecked.

When toilets and other components are connected to the piping system, vacuum in the piping system shall stay between -7.3 psi (-0.50 bar) and -5.1 psi (-0.35 bar) for at least 30 minutes, with no more than 2 vacuum pump starts per hour.

The leak test of the piping system must always be completed prior to start of service.

 Pressure Testing with Air is not recommended on plastic piping systems.



3.11 Vacuum Test Reporting Sheet

General

All piping must be leak-tested before toilets, interface valves and vacuum units are connected to the piping system. Individual sections must be checked for leaks prior to start of service.

Testing methods and requirements

Testing can be done by:

- Vacuum Test (recommended)
- Pressure Test with Water

Option 1: Vacuum Test:

-8.7psi (-0.60 bar) vacuum is created to the pipe, all possible leaks are to be removed until leak is limited to +0.2 psi/h (+0.014 bar/h)

Option 2: Pressure Water Test:

Piping is filled with water and pressurized to 43.5 psi (3 bar) for 30min. No water leaks are allowed.

Documentation of results

Always document the results (use enclosed test protocol).

Ship Hull No.: _____

Testing Method: Vacuum Water

No.	Piping Ident.	Tested By	Date	Approved By	Date
1					
2					
3					
4					
5					
6					
7					
8					
9					
10					
11					
12					
13					
14					
15					
16					
17					
18					
19					
20					

Installation

Content

1	Installation	56
1.1	Storage and Handling	56
1.2	Usage of Fixed Bracketing to Compensate for Expansion and Contraction	57
1.3	Fixed Horizontal and Vertical Support Installation	57
1.4	Horizontal and Vertical Support Spacing	58
1.5	Pipe Bracket Requirements	59
1.6	Arrangement of Fixed Brackets	59
1.7	Food Preparation (Galleys) or Food Storage Areas Governed by USPH	60
1.8	Protection from Bulkheads and Structural Supports	60
1.9	Situations to Avoid	61
1.10	Thermoplastic Piping Tools	62
1.11	Jointing by NPT/BSP Threads	63
1.12	Threaded Connections	64
1.13	Jointing by Van Stone Flanges	64
2	Testing	70

1 Installation

The following information is considered general in nature and provided as a reference for proper pipe installation to assist in ensuring the highest system integrity possible.

Thermoplastic piping systems must be designed, engineered, installed, and operated in accordance with accepted industry standards and practices, as well as any applicable code requirements. Suitability for the intended service must be clearly established prior to use. Proper selection, application, and installation of thermoplastic piping products are the responsibility of the end user.

1.1 Storage and Handling

Piping products from GF Piping Systems are inspected, handled, and loaded with great care at the factory using methods that have been developed specifically for thermoplastic piping products. This ensures that damage is minimized and overall quality is maintained during shipping. It is the carrier's responsibility to deliver the shipment in good condition. It is the receiver's responsibility to ensure that there has been no loss or damage and that the products are unloaded and stored properly after receipt. Reasonable care and common sense should be used when handling and storing GF Piping Systems thermoplastic piping products.

Thermoplastic pipe and fittings may be stored indoors or outside in yards. If stored outdoors, it is recommended that pipe and fittings should be protected from exposure to the elements, and pipe should be properly supported in storage to prevent sagging or bending. Pipe should be stored in the yard on level ground in the unit packages provided by the factory. Caution must be exercised to avoid compression, damage, or deformation. When unit packages are stacked, care must be used to ensure that the weight of the upper units does not cause deformation to pipe in the lower units. Package units should not be stacked more than 8 ft (2.5 m) high. Care must be used to ensure that the height of the stack does not result in instability, which can cause collapse, pipe damage, or personnel injury. Unit packages should be supported by wooden racks or other suitable means and spaced properly to prevent damage.

Thermoplastic pipe and fittings must not be stored in tightly enclosed areas subject to elevated temperatures or close to heat producing sources such as heaters, boilers, steam lines, engine exhaust, etc. Exposure to excessive temperatures will result in distortion and deformation of the product. When stored outdoors, thermoplastic pipe must be covered with non-transparent material. This covering must provide adequate air circulation above and around the pipe as required to prevent excessive heat absorption that can result in distortion and deformation of the product.

Although GF Piping Systems products are tough and corrosion resistant, they should not be dropped, have objects dropped on them, nor be subjected to external loads. Thermoplastics can be damaged by abrasion and gouging. Pipe must not be dragged across the ground or over obstacles. Impacts such as dropping and/or rough handling should be avoided particularly in cold weather. The product shall be inspected for any scratches, splits, or gouges that may have occurred from improper handling or storage. If found, damaged sections must be cut out and discarded.

1.2 Usage of Fixed Bracketing to Compensate for Expansion and Contraction

The use of fixed bracketing of Polypropylene is possible because it is not subject to stress cracking. It can be stressed for long periods of time in what might be considered unfriendly environments without harm.

Fixed restraint is a method of rigidly anchoring the pipe runs to the support structure at appropriate places. This allows the thermally-induced dimension changes to be replaced by thermally-induced stresses. This can be accomplished by use of adequately strong clamps or supports to hold the pipe in place.

 Where the pipe is exposed to excessive heat or potential impact damage, protective shields or coverings should be installed.

F = A x α x ΔT x E			
Symbol	Meaning	Imperial [metric] Values	Unit
F	Restraint Force		lbs [N]
A	Area of Wall		in ² [mm ²]
α	Coefficient of linear expansion	6.1x10 ⁻⁵ [0.11x10 ⁻⁴]	in/ft°F [mm/mm°C]
ΔT	Difference in Temperature		°F [°C]
E	Modulus of Elasticity	188,550 [1300]	lb/in ² [N/mm ²]

TIV.1 Restraint Force on 2 Fixed Brackets

Nominal Size (in)	A (in ²)	A (mm ²)	ΔT = 50°F (lbs)	ΔT = 100°F (lbs)	ΔT = 28°C (N)	ΔT = 56°C (N)
1½	0.799	518.4	460	919	2,056	4,111
2	1.075	691.0	618	1,236	2,740	5,480
2½	1.704	1097.8	980	1,960	4,353	8,705
3	2.228	1441.0	1,282	2,563	5,714	11,428
4	3.173	2041.4	1,825	3,651	8,094	16,188
6	5.584	3595.6	3,210	6,419	14,257	28,513

- For force imposed on a single bracket use: **Force (F) x 0.5**

 Each fixed bracket will take one-half of the generated force.

1.3 Fixed Horizontal and Vertical Support Installation

Pipelines need to be supported at specific intervals depending upon the material, the average pipe wall temperature, the diameter and wall thickness of the pipe. The determination of the pipe support centers is based on the permissible amount of deflection of the pipe between two brackets. The pipe bracket centers given on the next page are calculated to maximize span and minimize deflection between two brackets.

Vertical lines must also be supported at intervals so that the fittings at the lower end of a riser or column are not overloaded. The supports should not exert a compressive strain on the pipe such as riser-type clamps that squeeze the pipe.

If possible, clamps should be located just below a fitting so that the shoulder of the fitting rests against the clamp to support the weight of the vertical column. Horizontal take-offs from the riser should be independently supported.

Compared to horizontal runs, the effects of deflection on vertical risers is typically minimized and therefore the vertical spacing requirement can be increased by 30%, i.e. 3.0m horizontal spacing limit x 1.3 (30%) or 3.9m vertical spacing. Vertical piping should be maintained in straight alignment with supports at proper intervals. A mid-deck guide should be included when specified by the design engineer to compensate for movement and the additional elasticity of plastic piping systems. Mid-deck guides should always be used on 1½" (DN40) and 2" (DN50), and particularly on hot water lines subject to thermal effects.

 Support spacing is a function of:

- Pipe size
- Operating temperature
- Location of heavy valves or fittings
- Mechanical properties of the piping
- Specific gravity of water 1g/cm³

1.4 Horizontal and Vertical Support Spacing

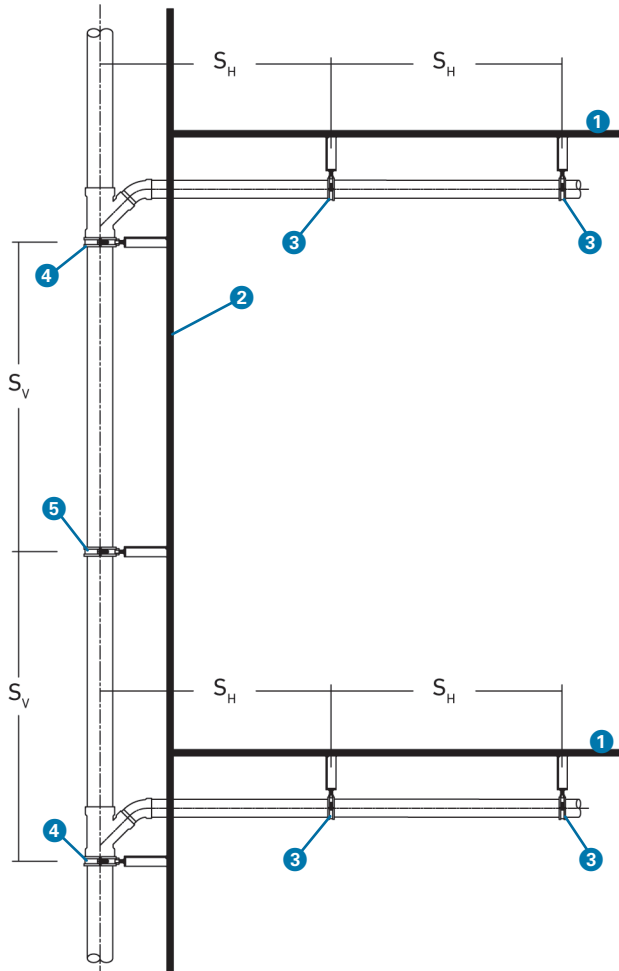

- 1 Deck
- 2 Bulkhead
- 3 Horizontal Support
- 4 Vertical Support
- 5 Mid-Deck Support

S_H - Horizontal Supports
 S_V - Vertical Supports
 $S_V = S_H \times 1.3$

TIV.2 Support Spacing

Size (inch)	SeaDrain White Span Distance in Feet (S_H)						
	73°F	120°F	140°F	160°F	180°F	200°F	212°F
1½	6.6	6.3	6.0	6.0	5.8	5.5	5.3
2	8.2	7.9	7.5	7.5	7.3	6.9	6.6
2½	9.8	9.5	9.0	9.0	8.7	8.3	7.9
3	9.8	9.5	9.0	9.0	8.7	8.3	7.9
4	9.8	9.5	9.0	9.0	8.7	8.3	7.9
6	9.8	9.5	9.0	9.0	8.7	8.3	7.9

Size (inch)	SeaDrain White Span Distance in Meters (S_H)						
	23°C	49°C	60°C	71°C	82°C	93°C	100°C
1½	2.0	1.9	1.8	1.8	1.8	1.7	1.6
2	2.5	2.4	2.3	2.3	2.2	2.1	2.0
2½	3.0	2.9	2.8	2.8	2.7	2.5	2.4
3	3.0	2.9	2.8	2.8	2.7	2.5	2.4
4	3.0	2.9	2.8	2.8	2.7	2.5	2.4
6	3.0	2.9	2.8	2.8	2.7	2.5	2.4



Concentrated loads such as valves, heavy fittings and components, etc. should be supported directly when possible and as closely as possible otherwise. SeaDrain White piping should not be used to support other objects by means of gang clamping.

Where fluids with a specific gravity exceeding 1g/cm^3 are to be conveyed, pipe spacing can be adjusted by dividing the support spacing by the specific gravity.

1.5 Pipe Bracket Requirements

Pipe brackets can be all plastic or metal with an integral rubber liner to protect from damaging the piping system from point loading and sized appropriately for the line size to prevent crushing. The inside edges of the pipe bracket must be formed in such a way that no damage to the pipe surface is possible.



Metal Clamp with Liner



KLIP-IT All Plastic Clamp (by GF)

- 1 Metal Pipe Bracket
- 2 Integral Rubber Liner

1.6 Arrangement of Fixed Brackets

A fixed point should not be a compressive force to hold the pipe but a design anchor that withstands the axial load. If the pipe bracket is positioned directly beside a fitting, the length change of the pipeline is limited to one direction only (one-sided fixed point).

If it is, as in most cases, necessary to control the length change of the pipeline in both directions, the pipe bracket must be positioned between two fittings. The pipe bracket must be robust and firmly mounted in order to take up the force arising from the length change in the pipeline. Hanger type brackets are not suitable as fixed points.

Fixed supports for Black Water

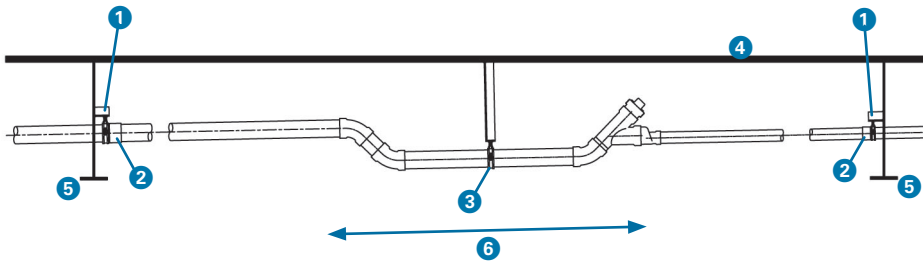

- 1 Fixed Support
- 2 Use of couplings between fixed supports restrains the pipeline from axial movement
- 3 While not required, it is recommended to add a support on the lower leg of a transport pocket.
- 4 Deck
- 5 Structural Support
- 6 Direction of Axial Movement

Fixed Supports for Gray Water

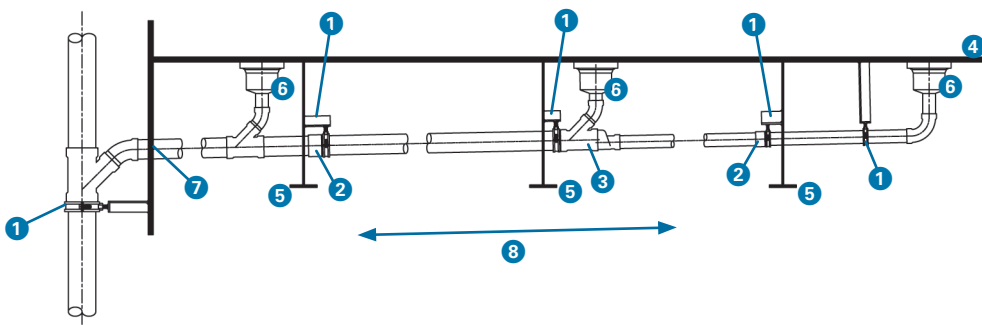

- 1 Fixed Support
- 2 Use of coupling between fixed supports restrains the pipeline from axial movement
- 3 Fittings can also be utilized to restrain the pipeline from axial movement
- 4 Deck
- 5 Structural Support
- 6 Deck Scupper
- 7 Bulkhead
- 8 Direction of Axial Movement

1.7 Food Preparation (Galley) or Food Storage Areas Governed by USPH

Within the food preparation and food storage areas, strict adherence to US Public Health (USPH) codes is required. With regard to SeaDrain White this means the following:

- Metal Drains must be connected utilizing GF's USPH Approved Transition
- All jointing must be Electrofusion within the area boundaries

Consideration needs to be taken that any hot discharges to the drain, such as from a dish sanitizer, have been taken into account with regard to support spacing. This includes piping outside of the USPH zones (as shown below).

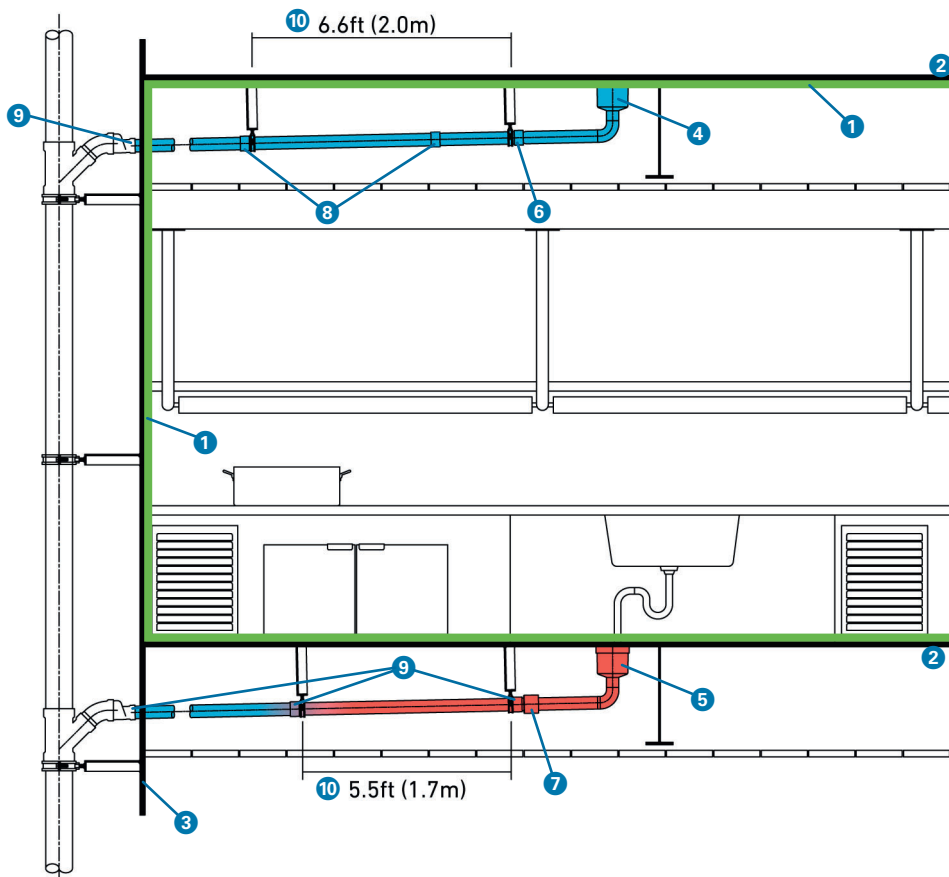

- 1 Food Prep Boundary
- 2 Deck
- 3 Bulkhead
- 4 Ambient Metallic Drain Scupper 73°F (23°C)
- 5 Hot SeaDrain White PPR Scupper 185°F (85°C)
- 6 Metal to SeaDrain White USPH Approved Transitions ONLY (ASTM F1973)
- 7 USPH Approved Transition of Push-Fit Transition
- 8 Electrofusion ONLY
- 9 Electrofusion or SeaDrain Fast-Lock
- 10 Temperature is accounted for in hanger spacing



This illustration references metal drains to demonstrate the proper transition usage.

SeaDrain White Drain Scuppers could also be used without the need for transitions.

1.8 Protection from Bulkheads and Structural Supports

Fixed points should be placed as necessary to remove the potential for the piping system to contact metal surfaces, such as decks, bulkheads and structural supports.

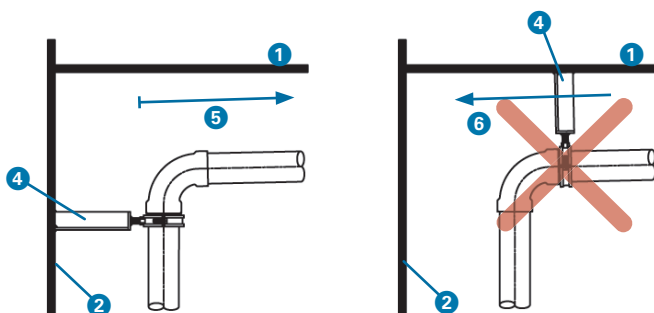

- 1 Deck
- 2 Bulkhead
- 3 Structural Support
- 4 Fixed Support
- 5 Piping is restrained from contacting Bulkhead or Structural Support
- 6 Piping has potential to contact Bulkhead or Structural Support

1.9 Situations to Avoid

Sagging at Changes of Direction

At horizontal changes of direction, supports should be placed within 2ft (0.6m) of the turn to reduce the chances of a low-point in the drainage system

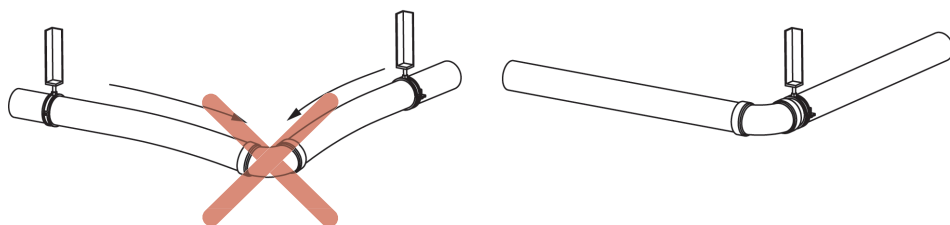

Twisting at Offsets

Where an offset is needed, it is best to have two hangers to reduce the chance of flex or twist in the piping system

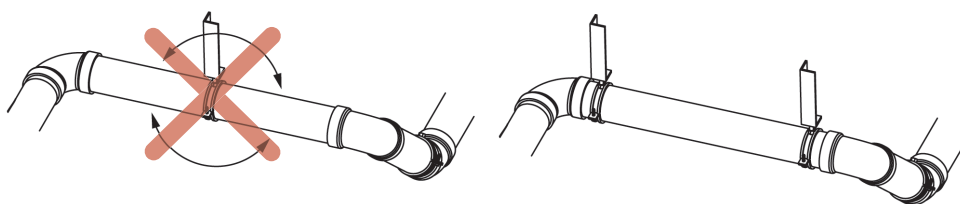

Excessive Stress at Vertical Changes

Hangers should be placed as close as possible to the fitting at **VERTICAL** changes of direction

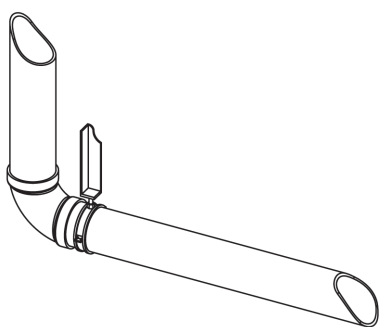

1.10 Thermoplastic Piping Tools

The use of tools that have been specifically designed for thermoplastic pipe and fittings is strongly recommended to obtain optimum results during installation. A variety of tools that are designed for cutting, beveling, and assembling plastic pipe and fittings are readily available through local wholesale supply houses dealing in plastic pipe and fittings. Improper use of tools normally used with metal piping systems, i.e. hacksaws, water pump pliers, pipe wrenches, etc., can cause damage to plastic pipe and fittings. Visible and non-visible fractures, scoring or gouging of material and overtightening of plastic threaded connections are some of the major problems associated with the use of incorrect tools and/or procedures.

Pipe Cutters

Plastic pipe must have square-cut ends to allow for the proper interfacing of the pipe end and the fitting socket bottom. A wheel type pipe cutter with special blades for plastic pipe provides easy and clean cutting action. The raised bead left on the outside of the pipe after cutting must then be removed. A miter box saw may also be used to produce square-cut ends.

Pipe Cutters for Large Diameter Pipe

Blade cutters made for use with large diameter plastic pipe are easy to adjust and operate for square, burr-less cuts. Blades with carbide edges will provide longer life. With all-in-one style blade cutter, pipe ends may also be beveled for jointing while the pipe is being cut.

Power Saws

Power saws specifically for use with plastic pipe are available. These are particularly useful in prefabrication operations where a large quantity of pipe is being cut. Blades designed for thermoplastic pipe **MUST** be used. Follow manufacturer's instructions regarding speed, set, and proper use of the tool.

Power Beveling Tools

Portable and mounted power beveling tools as well as hand beveling tools specifically designed for use with plastic pipe are available. Pipe ends must be beveled (chamfered) to allow easy insertion of the pipe into the fitting, and to help prevent dislocation or tearing of the rubber gasket or electrofusion coil. A recommended bevel of 3/32 in (2.5 mm) at a 10° to 15° angle can be quickly achieved using a plastic pipe beveling tool.

Deburring Tools

A smooth, beveled pipe end helps insertion as the pipe is joined to the fitting. All burrs must be removed from the inside as well as the outside of the pipe ends. Special plastic pipe deburring tools deburr pipe ends quickly and efficiently.

1.11 Jointing by NPT/BSP Threads

Threaded thermoplastic systems are not recommended for piping layouts where leaks would be dangerous. Larger pipe sizes have two definite advantages. They can be quickly dismantled for temporary or take-down applications, and they can be used to join thermoplastic to non-plastic materials. Theoretically, it is possible to use any combination of threaded parts, such as:

- Metal female to Plastic male
- Plastic male to Plastic female

A male plastic thread can be inserted into a female metal thread if heat is not involved and both lines are anchored immediately adjacent to the joint. However, male metal threads should NOT be connected to a female plastic pipe thread.

GIV.1 Dimensions of pipe threads as shown in the following tables

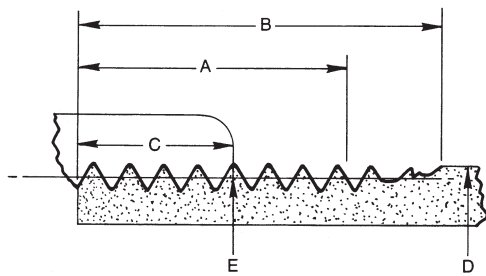

! Due to the differences in compression factors of metal and plastic, metal male thread fittings should not be joined to plastic female fittings under any circumstances.

TIV.3 American standard taper pipe thread dimensions in Imperial and Metric units

Pipe Size (IPS)	Pipe Size (DN)	Threads per inch	Maximum Depth of Thread (inch)	(A) Length of Effective Thread (inch)	(B) Total Length end of pipe to Vanish Point (inch)	(C) Normal engagement by Hand (inch)	(D) Outside Diameter (inch)	(E) Pitch Diameter at end of Internal Thread (inch)
1½"	40	11.5	0.069	0.723	1.025	0.420	1.900	1.822
2"	50	11.5	0.069	0.756	1.058	0.436	2.375	2.296
3"	80	8	0.100	1.200	1.633	0.766	3.500	3.388
4"	100	8	0.100	1.300	1.733	0.844	4.500	4.387

Pipe Size (IPS)	Pipe Size (DN)	Threads per inch (25.4mm)	Maximum Depth of Thread (mm)	(A) Length of Effective Thread (mm)	(B) Total Length end of pipe to Vanish Point (mm)	(C) Normal engagement by Hand (mm)	(D) Outside Diameter (mm)	(E) Pitch Diameter at end of Internal Thread (mm)
1½"	40	11.5	1.7	18.3	26.0	10.6	48.2	46.2
2"	50	11.5	1.7	19.2	26.8	11.0	60.3	58.3
3"	80	8	2.5	30.4	41.5	19.4	88.9	86.0
4"	100	8	2.5	33.0	44.0	21.4	114.3	111.4

1.12 Threaded Connections

Please read all instructions before attempting to install threaded parts.

NPT threaded connections are not recommended for high temperature systems, systems greater than 4in (DN100) or systems where leaks would be dangerous or costly. When properly installed, threaded connections offer the benefit of an easy and inexpensive transition to metal systems. They can also be used for jointing plastic where the installation is expected to be modified or moved later.

Thread Sealant

Use either a thread sealant (pipe dope) approved for thermoplastics or PTFE tape, but not both to seal threads.

Use a thin, even coat of sealant. PTFE tape must be installed in a clockwise direction starting at the bottom of the thread and overlapping each pass. Do not employ more than three wraps.



Pipe Dope

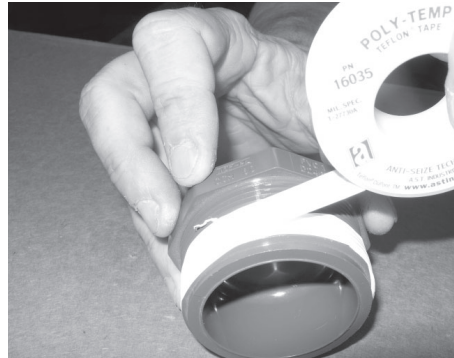

PTFE Thread Sealant

Making the Connection

Start the threaded connection carefully by hand to avoid cross threading or damaging threads. Turn until hand tight. Mark the location with a marker. With a strap wrench on the plastic part, turn an additional half turn.

If leakage occurs during pressure testing, consult the following table for next steps.

TIV.4 Steps to compensate for leakage during pressure testing

Connection Type	Next Step
Plastic to Plastic	Tighten up to ½ turn
Plastic Male to Metal Female	Tighten up to ½ turn

Threaded connections are susceptible to fracture or leaking due to misalignment. Pipe should be installed without bending.

1.13 Jointing by Van Stone Flanges

Please read all instructions before attempting to install flanges.

Like all thermoplastic pipe and fittings, flanges are light-weight, inexpensive, and easy to install. Thermoplastics have different physical properties than metals and special care is required to ensure that your flanges have a long, reliable service life. Installers should study these instructions and follow them carefully during installation in order to ensure satisfactory performance and enjoy the full benefits of the GF Piping Systems warranty.

Flanges are generally used when

- The piping system may need to be dismantled
- The installation needs to be temporary or mobile
- Transitioning between dissimilar materials that cannot be bonded together



Threaded connections cannot be used for transition in Food Preparation (Galley) or Food Storage Areas Governed by USPH



Due to the differences in compression factors of metal and plastic, metal male thread fittings should not be joined to plastic female fittings under any circumstances.

Gaskets

Visually inspect flanges for cracks, deformities, contaminants, and other obstructions on the sealing surfaces.

TIV.5 ANSI Gasket dimensions

Pipe Size (IPS)	Pipe Size (DN)	Minimum OD (inch)	(mm)	Maximum ID (inch)	(mm)
1½"	40	5.00	127.0	1.93	49.0
2"	50	6.00	152.0	2.44	62.0
2½"	65	7.00	178.0	2.91	73.9
3"	80	7.50	191.0	3.59	91.2
4"	100	9.00	229.0	4.64	118.0
6"	150	11.00	279.0	6.82	173.0

TIV.6 ISO/DIN Gasket Dimensions

Pipe Size (IPS)	Pipe Size (DN)	Minimum OD (inch)	(mm)	Maximum ID (inch)	(mm)
1½"	40	5.91	150.0	1.93	49.0
2"	50	6.50	165.0	2.44	62.0
2½"	65	7.28	185.0	2.91	73.9
3"	80	7.87	200.0	3.59	91.2
4"	100	8.66	220.0	4.64	118.0
6"	150	11.22	285.0	6.82	173.0

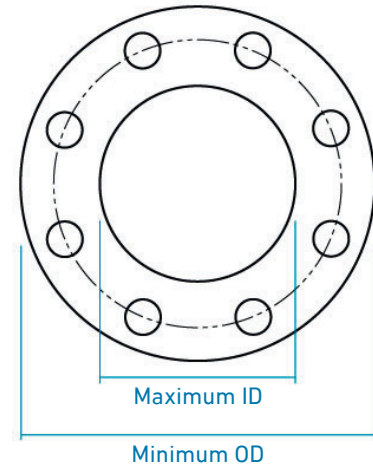

A rubber gasket must be used between flange faces in order to ensure a good seal. For SeaDrain White flanges, GF Piping Systems recommends a 0.125 in thick full-face gasket with a Shore A scale hardness of 70±5. The bolt torque values shown in table "TIV.8 Multiple Pass Bolt Torques Values" are based on this specification. For other hardness requirements, contact GF Technical Services. Select the gasket material based on the chemical resistance requirements of your system. A full-face gasket should cover the entire flange-to-flange interface without extending into the flow path.

Fasteners

It is critical to avoid excessive compression stress on Van Stone Flanges. Therefore, only low-friction fastener materials should be used. Low-friction materials allow torque to be applied in a steady and gradual manner. This ensures that the flanges are not subjected to sudden, uneven stress during installation that can lead to cracking.

Either the bolt or the nut, but preferably both, should be zinc-plated to ensure minimal friction. If using stainless steel bolts and nuts, lubricant must be used to prevent high friction and seizing. In summary, the following fastener combinations are acceptable:

- Zinc-on-zinc with or without lubricant
- Zinc-on-stainless steel with or without lubricant
- Stainless steel-on-Stainless steel with lubricant only

Cadmium plated fasteners, while becoming more difficult to obtain due to environmental concerns, are also acceptable with or without lubricant. Galvanized and carbon steel fasteners are not recommended. Use a copper-graphite anti-seize lubricant to ensure smooth engagement and the ability to disassemble and reassemble the system easily. Note the fastener specifications in the following table.

TIV.7 Fastener Specifications

Flange Size (inch)	No. of Bolts	Length (inch)	Length (mm)	Bolt Size Type (ANSI)	Washer Size Type (ANSI)
1½"	4	3¼"	85	½-UNC	½ SAE
2"	4	3½"	90	⅝-UNC	⅝ SAE
2½"	4	4"	105	⅝-UNC	⅝ SAE
3"	4 (8 for ISO/DIN)	4"	105	⅝-UNC	⅝ SAE
4"	8	4¼"	110	⅝-UNC	⅝ SAE
6"	8	4½"	115	¾-UNC	¾ SAE

Bolts must be long enough that two complete threads are exposed when the nut is tightened by hand. Using a longer bolt does not compromise the integrity of the flange connection although it may make tightening more difficult and interfere with nearby system components.

A washer must be used under each bolt head and nut. The purpose of the washer is to distribute pressure over a wider area, reducing the compression stress under the bolt head and nut. Failure to use washers voids the GF Piping Systems warranty.

Torque Wrench

Compared to metals, thermoplastics are relatively flexible and deform slightly under stress. Bolt torque must be controlled in order to avoid cracking the flange. Continuing to tighten the bolts beyond the recommended torque levels may actually make the seal worse, not better.

Experienced installers may be tempted to forego the use of a torque wrench, relying instead on feel. GF Piping Systems does not endorse this practice. Job-site studies have shown that experienced installers are only slightly better than new trainees at estimating bolt torque by feel. A torque wrench is always recommended.

Checking System Alignment

Before assembling the flange, be sure that the two parts of the system being joined are properly aligned. GF Piping Systems has developed a "pinch test" that allows the installer to assess system alignment quickly and easily with minimal tools.

Check the gap between flange faces by pinching the two mating components toward each other with one hand as shown below. If the faces can be made to touch, then the gap between them is acceptable.

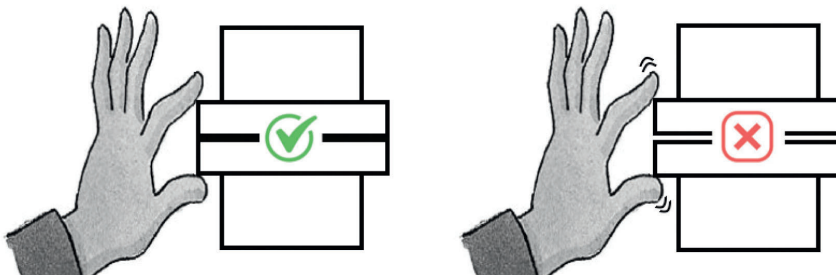

Suggested bolt length for flange-to-flange connections with 0.125in (3mm) thick gaskets. Adjust bolt length as required for other types of connections.

Note: Use of a stronger or thicker washer is always acceptable as long as published torque limits are observed.



Because bolt torque is critical to the proper function of a flange, a current calibrated torque wrench accurate to within ± 1ft-lb (1.36Nm) must be used when installing flanges.

Note: Never use an impact wrench to install a GF Piping Systems flange.

Check the angle between the flange faces. If the faces are completely flush when pinched together, as shown below, then the alignment is perfect and you may continue installation. Otherwise, pinch the faces together so that one side is touching; then measure the gap between the faces on the opposite side. The gap should be no more than $\frac{1}{8}$ in (3.2 mm).

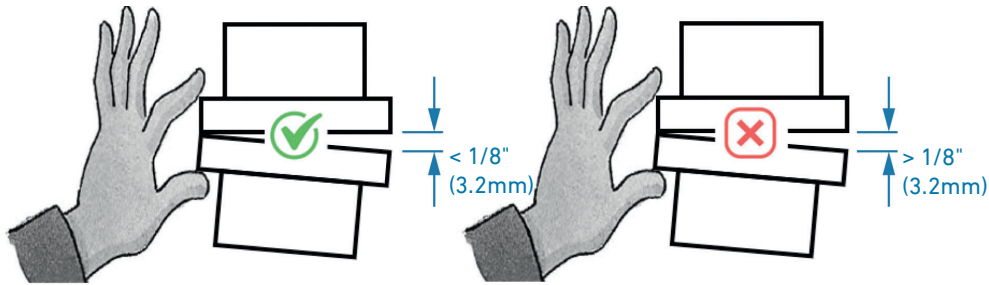

To assess high-low misalignment, pull the flange faces flush together. If the faces are concentric within $\frac{1}{8}$ in (3.2 mm), then the high-low misalignment is acceptable.

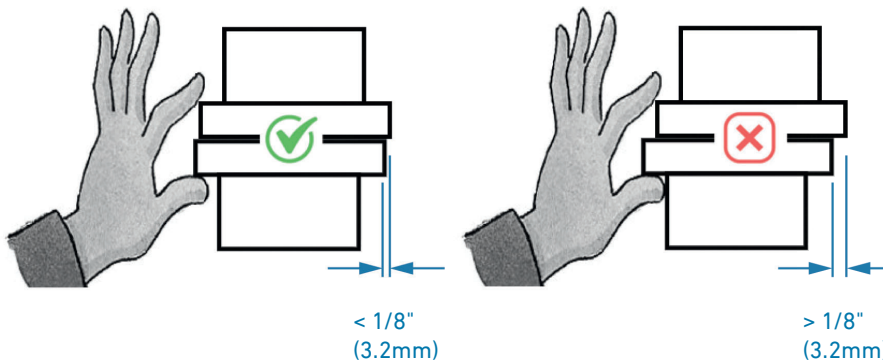

When the gap between the mating components cannot be closed by pinching them with one hand, or the high-low misalignment between them is too large, you should not use the bolts to force the components together. This method can result in excessive stress and possible failure during or after installation. In this case, inspect the system to find the greatest source of misalignment and refit the system with proper alignment before bolting.

The pinch test is a good rule of thumb, but always use common sense as well. If it seems difficult or awkward to pull the flange faces together, then stop the installation and either refit the system or consult your GF Piping Systems representative before proceeding.

The bolt holes of a Van Stone flange will align automatically when the bolts are inserted and tightened. No additional adjustment is necessary. To align the bolt holes of a fixed flange, use standard two-holing procedure.

Placing the Gasket

Center the gasket between the flange faces with the bolt holes aligned with corresponding holes in the gasket. A full-face gasket cut to the specified dimensions should come just to the inner edge of the flange face near the flow path or overlap the edge slightly. See the prior tables "ANSI Gasket dimensions" or "ISO/DIN Gasket Dimensions" for the specified dimensions.

Inserting the Bolts

If copper-graphite anti-seize lubricant is used as recommended, apply the lubricant evenly with a brush directly to the bolt threads and to the nut. Cover the bolt from its tip to the maximum extent to which the nut will be threaded. Insert bolts through washers and bolt holes.

Tighten all nuts by hand. As you tighten each nut, the nuts on the other bolts will loosen slightly. Continue to hand-tighten all of the nuts until none remain loose. Now the flange assembly will remain in place as you prepare to fully tighten it.

Again, when hand-tightened, at least two threads beyond the nut should be exposed in order to ensure permanent engagement. If less than two threads are exposed, disassemble the flange and use longer bolts.

Tightening the Bolts

SeaDrain White flanges require gradual, even bolt tightening. Tightening one bolt to the maximum recommended torque while other bolts are only hand-tightened or tightening bolts in the wrong order, produces uneven stresses that may result in cracking or poor sealing. To ensure even distribution of stresses in the fully installed flange, tighten the bolts in a star pattern as described in ANSI B16.5 and shown in the following diagram.

GIV.2 Bolt tightening order

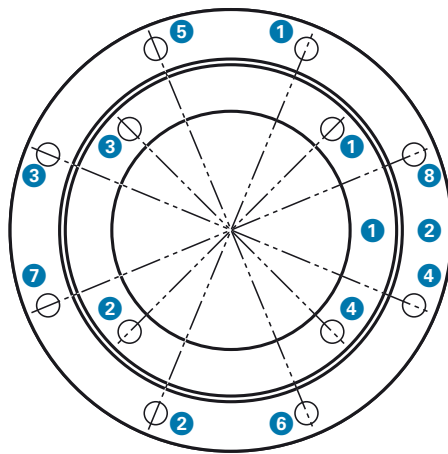

- 1 4-Bolt Pattern
- 2 8-Bolt Pattern

For the installer's convenience, this pattern is also indicated by numbers molded into the flange next to each bolt hole.

In order to achieve the best seal with minimal mechanical stress, the torque required on each bolt is shown in the following table.

TIV.8 Multiple Pass Bolt Torques Values

Pipe Size (inch)	Pipe Size (DN)	Torque Values, lubed (ft-lb)			Torque Values, lubed (Nm)		
		1st	2nd	3rd	1st	2nd	3rd
1½	40	3	5	-	4.1	6.8	-
2	50	5	8	-	6.8	10.9	-
2½	65	5	8	10	6.8	10.9	13.6
3	80	5	12	15	6.8	16.3	20.4
4	100	10	15	20	13.6	20.4	27.2
6	150	12	24	30	16.3	32.6	40.8

TIV.9

Pipe Size (inch)	Pipe Size (DN)	Torque Values, unlubed (ft-lb)			Torque Values, unlubed (Nm)		
		1st	2nd	3rd	1st	2nd	3rd
1½	40	5	8	-	6.8	10.9	-
2	50	5	10	12	6.8	13.6	16.3
2½	65	10	15	18	13.6	20.4	24.5
3	80	15	20	25	20.4	27.2	34.0
4	100	15	25	32	20.4	34.0	43.5
6	150	20	32	42	27.2	43.5	57.1

To ensure even distribution of stresses and a uniform seal, tighten the bolts to the first torque value in the sequence using a star pattern; then, repeat the star pattern while tightening to the next torque value. Continue this pattern to the maximum torque value.

Thermoplastics deform slightly under stress. A final tightening after 24 hours is recommended, when practical, to ensure any bolts that have loosened due to relaxation of the polymer are fully engaged.

If a flange leaks when pressure tested, retighten the bolts to the full recommended torque and retest. Do not exceed the recommended torque before consulting an engineer or GF Piping Systems representative.

Note that the torques listed in the prior table are for flange-to-flange connections in which the full faces of the flanges are in contact. For other types of connections, such as between a flange and a butterfly valve, where the full face of the flange is not in contact with the mating component, less torque will be required. Do not apply the maximum listed torque to the bolts. In such connections, the flange is not fully supported by the mating component, as this may cause deformation or cracking. In this case start, with approximately two-thirds of the listed maximum torque and increase as necessary to make the system leak-free after pressure testing.

Documentation

Keep instructions available and provide a copy of these instructions to every installer on the job site prior to beginning installation. Installers who have worked primarily with metal flanges often make critical mistakes when installing plastic flanges. Even experienced installers will benefit from a quick review of good installation practices before starting a new job.

Best practices include tagging each flange with installation tags including:

- Installer's initials
- Installation date
- Final torque value
- Confirmation of 24 hour torque check

The information can be recorded on pre-printed stickers as shown below and placed on each flange immediately after installation.

GIV.3 Example installation tag

The image shows a rounded rectangular form with a blue border. It contains four rows, each with a rectangular input field on the left and a label on the right:

- Input field: [] Label: Installed by
- Input field: [] Label: Date
- Input field: [] Label: Final Torque (ft-lb) / (Nm)
- Input field: [] Label: 24-Hour Check

Experience has shown that installation tags speed up the process of resolving system leaks and product failures.

2 Testing

Hydrostatic pressure testing (testing with water filled lines) is the only test method recommended and approved for pressure testing of GF Piping Systems piping products. During pressure testing, appropriate safety precautions must be taken to protect personnel and property from damage should a failure occur. The test pressure and duration of the pressure test performed should meet requirements of any government or certifying body. In the absence of any such requirements, the following process can be used to properly conduct a hydrostatic pressure test on newly installed SeaDrain White piping systems.

Strict adherence to proper jointing instructions is essential to ensure the highest system integrity prior to pressure testing. Particular attention should be paid to pipe sizes, temperature at time of installation, and any temperature variations since the completing of jointing.

1. All electrofusion connections in the system must be fully cooled down prior to filling the system with water.
2. Pipe must be adequately anchored/restrained to prevent movement during testing.
3. The system should not be tested until authorized and subsequently witnessed by the responsible inspector.
4. Extreme care shall be used to ensure complete venting of all entrapped air when filling the system with water. Entrapped air is a major cause of excessive surge pressures that result in burst failures of rigid plastic piping systems.
5. Air must be removed from the system to prevent it from being locked in the system when pressure is applied.
6. The system should include the use of vent valves located at high points in the system to vent air during filling as well as during normal operation of the system.
7. The system must be filled slowly with water, venting air from valves at piping run ends and at elevations during the filling process. Any slow build-up of gauge pressure or any rapidly fluctuating gauge needle on a completely liquid filled system, is a strong indication that air is present within the system. Should this occur, pressure should be immediately released and the line re-bled.
8. When testing thermoplastic piping systems, all tests should not exceed the pressure rating of the lowest rated component in the piping system. Test the system at 150% of the designed operational pressure, i.e. if the system is designed to operate at 14.5 psi (1 bar), then the test should be done at 21.8 psi (1.5 bar).
9. Allow one hour for the system to stabilize after reaching the desired pressure. If there is a pressure drop after one hour, increase pressure back to the desired amount and hold for 30 minutes. If the pressure drops by more than 6%, check the system for leaks.
10. A test period of two hours is usually considered satisfactory to demonstrate the integrity of the system.
11. If a leak is found, the pressure must be relieved and the failed section cut out, replaced, and rejoined properly prior to recharging and retesting the system.

GF Piping Systems recommends that large and/or complex systems be tested in segments as they are installed. This allows for evaluation and correction of improper installation techniques or other deficiencies as the project progresses.

Compressed air or gases must never be used for testing of SeaDrain White piping systems. Improper installation, especially poor workmanship in jointing techniques, can lead to an abrupt release of tremendous stored energy in the presence of compressed air or gas. This abrupt release of energy creates a surging of the pipe that can shatter the pipe and fittings at directional changes and at points where the system is rigidly restricted. This scenario creates a substantial safety hazard to personnel. In addition, secondary hairline stress fractures caused by this effect can also be initiated. This tends to propagate over time resulting in additional failures.



Warning:

Use of compressed air or gas in the testing of Thermoplastic pipe and fittings can cause explosive failures resulting in system damage, severe bodily injury or death.

Joining Technologies

Content

1	Joining Technolgies	72
2	SeaDrain Fast-Lock Joining	72
2.1	Required Tools.....	72
2.2	Pipe Preparation.....	72
2.3	Socket Preparation.....	73
2.4	Joint Assembly.....	73
2.5	Fast-Lock Installation.....	73
3	Electrofusion Joining	74
3.1	Required Tools.....	74
3.2	Pipe Preparation.....	74
3.3	Joint Assembly.....	74
3.4	Fusion Joining.....	75

1 Jointing Technologies

The jointing instructions outlined here are considered for reference only and will not be sufficient to meet the requirements of the SeaDrain White Type Approvals. You should always contact your local GF representative for authorized training and certification.

2 SeaDrain Fast-Lock Jointing

The new SeaDrain Fast-Lock Jointing System is a revolutionary new mechanical joint (MJ) solution for our SeaDrain White marine waste piping system. It is fast and easy to install. Unlike cemented systems, it does not require special cement or applicators, nor are there any toxic fumes. Most importantly, there is no cure time to wait for. Fast-Lock is the most compact mechanical jointing system on the market, which allows for installation of the system in tight spaces, such as close to bulkheads or next to deck support structures.

2.1 Required Tools

SeaDrain Fast-Lock fittings are pre-assembled at the factory. The following tools are needed to complete a proper installation:

- Pipe Chamfering Tool
- Isopropyl Alcohol – 70% minimum concentration or Tangit Cleaner for PE/PP/PB/PVDF
- Disposable Shop Towels or Wipes
- Silicon-based Lubricant (Dow Corning Molykote 111 or similar)
- Hand-held Power Drill or Ratchet
- 8mm and 10mm Sockets
- Torque-Limiter Recommended
- Spreader Tool



*(For proper use and safety regulations of IPA, please see supplier's Material Safety Data Sheets)

2.2 Pipe Preparation

1. Cut pipe end square with axis of pipe. **Use a fine tooth hand saw and miter box, a power cutoff saw with blade for plastic or a wheel type pipe cutter for plastic.
2. Chamfer the pipe end to ease insertion of the pipe and ensure that the gasket is not damaged and makes a proper seal.
3. Clean pipe surface with minimum 70% Isopropyl Alcohol (IPA*), and remove any debris on Fast-Lock Collar. Check pipe for any scratches or damage. The sealing area of the pipe must be smooth. If the fittings have become excessively dirty due to the atmosphere, Fast-Lock collars and gaskets should be carefully removed to then clean the fitting and gasket of debris and dirt. Care should be taken to prevent damage to collar rib and teeth when removing the Fast-Lock collar and gasket.
4. Mark socket depth on the pipe per the following table.



**Ratchet Type pipe cutters are not recommended

Regardless of the tool, the pipe needs to remain round and the end cut square.



A proper chamfer will ease insertion of pipe and prevent damage to sealing gasket.

Pipe Size (IPS)	Pipe Size (DN)	Socket Depth (inch)	Socket Depth (mm)
1½	40	1⅛	29
2	50	1¼	32
2½	65	1⅜	35
3	80	1½	38
4	100	1½	38

2.3 Socket Preparation

1. Rotate Fast-Lock collar to position bolts in an easily accessible location for tightening. Check to insure there is clearance between the pipe and collar before attempting to insert pipe. If necessary, use "spreader" tool to provide clearance before inserting pipe.

2.4 Joint Assembly

1. Insert the pipe into the fitting and push to the pipe stop. The chamfered bevel on the pipe will "spread" the collar to allow insertion. To ease pipe insertion, rotate pipe during insertion. The pipe must be fully inserted into the fitting socket to the pipe stop.
2. a) For 1½", 2" and 2½" Fast-Lock collars, tighten the bolts until the nibs touch.
b) For 3" and 4" Fast-Lock collars, tighten the bolts evenly until the collars touch. To accomplish even tightening, alternate between each side. Tighten first side to the approximate halfway point, then tighten alternate side to approximate halfway point. Complete tightening original side until collars touch, then tighten alternate side until collars touch. Check to ensure the collars are touching on both sides.

Do not overtighten! Overtightening can cause damage to bolt threads and/or collar. Maximum torque values are shown below.

Pipe Size (IPS)	Pipe Size (DN)	Torque Value (in-lb)	Torque Value (Nm)
1½	40	35	4
2	50	35	4
2½	65	35	4
3	80	75	8.5
4	100	75	8.5

2.5 Fast-Lock Installation

The Fast-Lock joining method can be installed in the available socket of any SeaDrain White electrofusion fitting. The following are instructions on installing a Fast-Lock joint in place of an Electrofusion joint.

1. Clean inside of fitting socket thoroughly and look for any damage on the sealing surface. Insert gasket into the socket. Make sure the collar rib is flush with the end of the socket.
2. Liberally apply lubricant to the inside of gasket and outside of pipe using a silicon-based lubricant, such as Dow Corning Molykote 111.
3. a) For 1½", 2" and 2½" Fast-Lock collars, using "spreader" tool, open collar and slide onto end of fitting. Ensure that the rib on the inside of the collar is seated in the groove on the outer edge of the fitting.

Install the bolt by hand. To avoid damaging the bolt threads, ensure that the bolt and insert threads are aligned properly before tightening.

b) For 3" and 4" Fast-Lock collars, slide first half of split collar onto fitting from the side. Ensure that the rib on the inside of the collar is seated in the groove on the outer edge of the fitting.

Slide second half of split collar onto fitting from the side. Ensure that the rib on the inside of the collar is seated in the groove on the outer edge of the fitting.

Install the bolts by hand. To avoid damaging the bolt threads, ensure that the bolt and insert threads are aligned properly before tightening. The Fast-Lock fitting socket is now ready for use.



Fast-Lock fitting gaskets are pre-lubricated at the factory to aid in pipe insertion.

Applying additional lubricant is not required on standard fittings .



Do not exceed 75 in-lb on 3" and 4" joints.



Use of a torque limiter will help to ensure proper tightening force is used.



Some pipe deformation at the clamping point is normal.



When replacing Electrofusion with Fast-Lock in the same fitting it is recommended that the base or original fitting be Electrofusion so that the fusion joint is not contaminated with lubricant.

3 Electrofusion Jointing

3.1 Required Tools

SeaDrain Electrofusion fittings are pre-assembled at the factory. The following tools are needed to complete a proper installation:

- Pipe Chamfering Tool
- Isopropyl Alcohol – 70% minimum concentration or Tangit Cleaner for PE/PP/PB/PVDF
- Disposable Shop Towels or Wipes
- MSA 2 Multi or Electro Plus

3.2 Pipe Preparation

1. Cut pipe end square with axis of pipe! **Use a fine tooth hand saw and miter box, a power cutoff saw with blade for plastic or a wheel type pipe cutter for plastic.
2. Chamfer the pipe end to ease insertion of the pipe and to prevent the fusion coil from being damaged.

3.3 Joint Assembly

1. Clean the pipe surface and inside of fitting socket with Isopropyl Alcohol* (IPA) or Tangit Cleaner for PE/PP/PB/PVDF.

The alcohol concentration must be at least 70%!

Do not handle the freshly cleaned surfaces before assembling.

If the fittings have become excessively dirty due to the environment, collars should be carefully removed and the fittings hub and collar cleaned of debris and dirt. Care should be used when removing collar.

2. Mark socket depth on the pipe per the following table.

Pipe Size (IPS)	Pipe Size (DN)	Socket Depth (inch)	Socket Depth (mm)
1½	40	7/8	22
2	50	1	25
2½	65	1 1/16	27
3	80	1 1/16	27
4	100	1 1/16	27
6	150	1 3/32	33

3. Rotate the fusion collar for easy access to the duplex receptacle and make sure the collar is completely seated.
4. Rotate the plastic clamp to orient the ratchet closure to the right or left of the duplex receptacle.

For 6" joints only, fit the steel band clamp to orient the T-handle on the right or left side of the duplex receptacle.

5. Insert the pipe into the fitting and push to the pipe stop. The pipe must be fully inserted into the fitting socket to the pipe stop. Rotate the collar so the socket depth mark is visible when looking at the duplex receptacle.

Check socket depth mark to be sure the pipe is fully inserted.



When replacing Electrofusion with Fast-Lock in the same fitting it is recommended that the base or original fitting be Electrofusion so that the fusion joint is not contaminated with lubricant.



*(For proper use and safety regulations of IPA, please see supplier's Material Safety Data Sheets)



**Ratchet Type pipe cutters are not recommended

Regardless of the tool, the pipe needs to remain round and the end cut square.



A proper chamfer will ease insertion of pipe, and prevent damage to sealing gasket.

6. The fusion collar must be fully seated in the fitting socket. This can be easily verified by looking for a lack of gap between the fusion collar and the fitting. If a gap is present, tap the fusion collar carefully on the top, for example with channel lock pliers, until there is no longer a gap and the collar is fully seated in the fitting!

A mark can be applied to the bottom of the collar to verify proper seating.

Due to the absence of a gap on 6" fusion collars a mark is required.

7. Tighten the clamp firmly before fusion. Proper clamp tightness will result when the pipe can not be rotated in the fitting socket. For 6" metal clamps, tighten to 65 in-lb.

For 6" only: Begin tightening the steel band clamp by hand using the T-handle. Once aligned, complete tightening with a torque tool. Tighten clamp to 65 in-lb. Torque tools and modified sockets are available.

Use a channel lock #440 for 1½"-3" plastic clamps. GF Part # 37X004817

Use a channel lock #460 for 4" plastic clamps. GF Part # 37X004818

6" Metal Clamp Torque Tool Usage Instructions:

Attach modified socket to square drive of tool. The spring loaded ball will retain the socket. The ratchet style or T-handle style can be used, depending on preference and/or space limitations.

Assemble pipe/fitting/collar/clamp fusion joint following GF Fuseal installation procedures. Complete tightening of clamp using a torque tool with the modified socket on the metal clamp T-handle. Make sure the pipe/fitting/collar/clamp assembly is properly aligned and seated before using torque tool. Each tool is pre-set to the appropriate torque.

8. Grasp handle at furthest point away from drive and turn smoothly and evenly. When the pre-set torque is reached, you will feel a sharp snap. The tool has reached its value and has reloaded. The first brake will most likely be a surprise. Smoothly cycle the tool a few more times, since over tightening is impossible. This will help assure the clamp is properly torqued down.

3.4 Fusion Joining

1. Check the continuity of every fusion collar with the continuity tester before fusing. A green light will indicate a good fusion collar.
2. Connect the factory-supplied fusion cables to the duplex receptacle of the fusion collars. Check how many joints are possible per fusion cycle.
3. Follow machine operating instructions for fusion cycle.
4. Tighten the band clamps within 30 seconds after the fusion cycle is finished!
 - a) For 1½"-4", tighten the fusion clamp approximately 1 to 2 clicks; do not exceed 2 clicks. If the clamp breaks, replace immediately.
 - b) For 6" only: Tighten the steel band clamp approximately ½ to one full turn.
5. Allow the joint to cool to the touch before testing.
 - a) The plastic clamps for 1½" - 4" can stay on the fittings. If you must remove them, wait for the joint to cool and remove with caution as the clamp is under pressure and may fracture.
 - b) The steel band clamp on the 6" fittings can be removed after a cooling time of 10 minutes.



Note: Clamp does not prevent pipe from being pulled out during handling.



Use of a torque limiter will help to ensure proper tightening force is used.



Note: Contact your local GF Sales Office for Machine Operating Instructions.

Special Considerations

Content

1	Chemical Compatibility Awareness.....	78
1.1	Thread Sealants.....	78
1.2	Fire Stop Materials.....	78
1.3	Anti-Freeze Solutions.....	78
1.4	Soldering/Hot Work.....	78
1.5	Flexible Wire.....	78
1.6	Steel Pipe Transitions.....	78
1.7	Paint.....	79
2	Disclaimer of Liability.....	79
2.1	Safety Alerts.....	79
3	Reference Tables.....	80
3.1	Pipe Capacity - Schedule 40.....	80
3.2	Weight of Water.....	80
3.3	Length.....	80
3.4	Area.....	80
3.5	Volume.....	81
3.6	Mass.....	81
3.7	Density.....	81
3.8	Force.....	81
3.9	Mass.....	82
3.10	Energy.....	82
3.11	Velocity.....	82
3.12	Flow Rate.....	82
3.13	Pressure.....	83

1 Chemical Compatibility Awareness

Thermoplastic piping continues to gain wide acceptance and use. Occasionally certain chemicals found in construction products and specific site preparations can cause damage to thermoplastic piping systems, such as thread sealants, lubricants, anti-freeze solutions, fire stop materials, etc. It is important to verify the compatibility of materials that come in contact with the piping system to ensure long-term performance.

Always check with GF if you have questions regarding chemical compatibility. If chemical compatibility with the thermoplastic remains in question, it is recommended to isolate the suspect product from direct contact with the thermoplastic piping system.

In general, thermoplastics may be more susceptible to stress cracking agents than can be found in certain ancillary products. The following list has been generated to create awareness that the potential for damage exists. Please note that a chemical compatibility program exists where a list of acceptable and unacceptable products is maintained. Please contact the GF Technical Services Department for the latest information.

1.1 Thread Sealants

Some thread paste sealants contain solvents or other chemical additives that can cause damage to thermoplastic pipe and fittings. Only compatible thread sealants and tapes should be used.

1.2 Fire Stop Materials

Some fire stop sealants contain solvents or other chemical additives that can cause damage to thermoplastic pipe and fittings. Only compatible fire stop materials should be used.

1.3 Anti-Freeze Solutions

DO NOT use glycol based antifreeze solutions. The improper use of anti-freeze solutions, such as ethylene glycol, propylene glycol and/or contaminated glycerin solutions, can cause stress cracking of thermoplastic pipe and fittings resulting in piping system failure.

1.4 Soldering/Hot Work

Soldering of metallic components in close proximity to thermoplastic piping systems will cause damage to the system. Direct contact with heat (open flame), solder, and soldering flux is not recommended. These types of products should be isolated from direct contact with thermoplastic piping products. Thermoplastic contact with solder flux can cause cracks, leaks, and breaks in the piping system. Thermoplastic pipe or fitting(s) that have solder flux on them, as identified by staining or discoloration of the pipe and fittings, should be removed and replaced with new materials.

1.5 Flexible Wire

Direct contact with flexible wire and cable should be avoided as the insulation for the wire and cable can contain plasticizers. This can cause thermoplastic piping systems to crack, leak, or break. The finished installation should be inspected to verify that wires or cables have not been pulled over and are not inadvertently being supported by the installed piping system. Thermoplastic piping systems should not be supported with electrical cable or flexible wiring and all hanger support recommendations should be followed.

1.6 Steel Pipe Transitions

Transitions from steel pipe to thermoplastic pipe can be made through a variety of methods, such as threaded, flanged, and grooved transition components. Occasionally, steel pipe may contain residual oils that were used to aid in the metal cutting process. Some of the oils used for this purpose may be incompatible with thermoplastics. Cutting oils should be removed from steel pipe prior to connecting it to thermoplastic pipe by thoroughly cleaning the inside and outside of the pipe before it is assembled in the piping system. Care should be taken when selecting cleaning agents to avoid further contamination of the pipe with incompatible detergents. If cutting oil is used, consult with the manufacturer of the cutting oil for a specific recommendation as to compatibility with thermoplastic systems.

1.7 Paint





Oil or solvent based paints may be chemically incompatible with thermoplastics. Water based acrylic or latex paint is the preferred paint to use on thermoplastic pipe and fittings. The installation contractor must take responsibility for obtaining approval from the authority having jurisdiction to cover the markings on the product (i.e. product identification, listing marks, etc.).

2 Disclaimer of Liability

As the conditions or methods of use are beyond our control, we do not assume liability for any use of this material. Information contained herein is believed to be true and accurate. All statements or suggestions are made without warranty, expressed or implied, regarding accuracy of the information. Compliance with all applicable federal, state, and local laws and regulations remains the responsibility of the user.

2.1 Safety Alerts

Several varieties of safety alerts and related messages appear in this catalog. Please be sure you understand the meaning of the key words that identify each type of alert.

 <p>“Warning” signifies hazards or unsafe practices that can cause severe personal injury or death if instructions, including recommended precautions, are not followed.</p>	 <p>“Caution” signifies hazards or unsafe practices that can cause minor injury or product or property damage if instructions, including recommended precautions, are not followed.</p>	 <p>“Note” signifies important special instructions.</p>	 <p>“GF Recommendation” signifies a general recommendation based on industry standard practices or expertise.</p>
--	---	--	---

The data furnished herein is provided as a courtesy and is based on past experience, limited testing, and other information believed to be reliable. This information may be considered as a basis for recommendation only. No guarantee is made as to its accuracy or suitability for particular applications.

3 Reference Tables

3.1 Pipe Capacity - Schedule 40

Pipe Size (inch)	Pipe Size (DN)	ID (inch)	Imperial			Metric		
			(inch ³)	(ft ³)	(gal)	(cm ³)	(mm ³)	(L)
1½	40	1.610	24.4	0.014	0.106	400.34	4.00 × 10 ⁵	0.400
2	50	2.067	40.2	0.023	0.174	659.86	6.60 × 10 ⁵	0.660
2½	65	2.469	57.4	0.033	0.249	941.49	9.41 × 10 ⁵	0.941
3	80	3.068	88.7	0.051	0.384	1454	1.45 × 10 ⁶	1.454
4	100	4.026	152.7	0.088	0.661	2503	2.50 × 10 ⁶	2.503
6	150	6.065	346.6	0.201	1.501	5681	5.68 × 10 ⁶	5.681

3.2 Weight of Water

Units	Pounds (lb)	Kilograms (kg)
1 gallon (gal)	8.35	3.79
1 liter (L)	2.21	1
1 cubic yard (yd ³)	1686	765
1 cubic foot (ft ³)	62.4	28.3
1 cubic inch (in ³)	0.036	0.016
1 cubic centimeter (cm ³)	0.002	0.001
1 cubic meter (m ³)	2210	1000

3.3 Length

	Convert To, Multiply By:								
		milli- meters (mm)	centi- meters (cm)	meters (m)	kilometers (km)	inches (in)	feet (ft)	miles (mi)	nautical miles (nmi)
Convert From	millimeters (mm)	1	0.1	0.001	1×10 ⁻⁶	0.0394	3.28×10 ⁻³	6.22×10 ⁻⁷	5.40×10 ⁻⁷
	centimeters (cm)	10	1	0.01	1×10 ⁻⁵	0.394	0.0328	6.22×10 ⁻⁶	5.40×10 ⁻⁶
	meters (m)	1000	100	1	0.001	39.4	3.28	6.21×10 ⁻⁴	5.40×10 ⁻⁴
	kilometers (km)	1×10 ⁶	1×10 ⁵	1000	1	3.94×10 ⁴	3281	0.621	0.540
	inches (in)	25.4	2.54	0.0254	2.54×10 ⁻⁵	1	0.0833	1.58×10 ⁻⁵	1.37×10 ⁻⁵
	feet (ft)	305	30.5	0.305	3.05×10 ⁻⁴	12	1	1.89×10 ⁻⁴	1.65×10 ⁻⁴
	nautical miles (nmi)	1.85×10 ⁶	1.85×10 ⁵	1852	1.85	7.29×10 ⁴	6076	1.15	1

3.4 Area

	Convert To, Multiply By:							
		square millimeters (mm ²)	square centimeters (cm ²)	square meters (m ²)	square kilometers (km ²)	square inches (in ²)	square feet (ft ²)	square miles (mi ²)
Convert From	square millimeters (mm ²)	1	0.01	1×10 ⁻⁶	1×10 ⁻¹²	1.55×10 ⁻³	1.08×10 ⁻⁵	3.86×10 ⁻¹³
	square centimeters (cm ²)	100	1	1×10 ⁻⁴	1×10 ⁻¹⁰	0.155	1.08×10 ⁻³	3.86×10 ⁻¹¹
	square meters (m ²)	1×10 ⁶	1×10 ⁴	1	1×10 ⁻⁶	1550	10.8	3.86×10 ⁻⁷
	square kilometers (km ²)	1×10 ¹²	1×10 ¹⁰	1×10 ⁶	1	1.55×10 ⁹	1.08×10 ⁷	0.386
	square inches (in ²)	645	6.45	6.45×10 ⁻⁴	6.45×10 ⁻¹⁰	1	6.94×10 ⁻³	2.49×10 ⁻¹⁰
	square feet (ft ²)	9.29×10 ⁴	929	0.0929	9.29×10 ⁻⁸	144	1	3.59×10 ⁻⁸
	square miles (mi ²)	2.59×10 ¹²	2.59×10 ¹⁰	2.59×10 ⁶	2.59	4.01×10 ⁹	2.79×10 ⁷	1

3.5 Volume

		Convert To, Multiply By:							
		cubic inches (in ³)	cubic feet (ft ³)	cubic yards (yd ³)	gallons (gal)	cubic millimeters (mm ³)	cubic centimeters (cm ³)	cubic meters (m ³)	liters (L)
Convert From	cubic inches (in ³)	1	5.79×10 ⁻⁴	2.15×10 ⁻⁵	4.33×10 ⁻³	1.64×10 ⁴	16.4	1.64×10 ⁻⁵	0.0164
	cubic feet (ft ³)	1728	1	0.0370	7.46	2.83×10 ⁷	2.83×10 ⁴	0.0283	28.3
	cubic yards (yd ³)	4.66×10 ⁴	27.0	1	202	7.63×10 ⁸	7.63×10 ⁵	0.763	763
	gallons (gal)	231	0.134	4.95×10 ⁻³	1	3.79×10 ⁶	3.79×10 ³	3.79×10 ⁻³	3.79
	cubic millimeters (mm ³)	6.10×10 ⁻⁵	3.53×10 ⁻⁸	1.31×10 ⁻⁹	2.64×10 ⁻⁷	1	1×10 ⁻³	1×10 ⁻⁹	1×10 ⁻⁶
	cubic centimeters (cm ³)	0.0610	3.53×10 ⁻⁵	1.31×10 ⁻⁶	2.64×10 ⁻⁴	1000	1	1×10 ⁻⁶	0.001
	cubic meters (m ³)	6.10×10 ⁴	35.3	1.31	264	1×10 ⁹	1×10 ⁶	1	1000
	liters (L)	61.0	0.0353	1.31×10 ⁻³	0.264	1×10 ⁶	1000	0.001	1

3.6 Mass

		Convert To, Multiply By:							
		ounce	pound	kilogram	metric slug	slug	short ton	metric ton	long ton
Convert From	ounce	1	0.0625	0.0283	2.89×10 ⁻³	1.94×10 ⁻³	3.13×10 ⁻⁵	2.83×10 ⁻⁵	2.79×10 ⁻⁵
	pound	16.0	1	0.452	0.0463	0.0311	5.00×10 ⁻⁴	4.54×10 ⁻⁴	4.46×10 ⁻⁴
	kilogram	35.3	2.21	1	0	0.0685	1.10×10 ⁻³	1×10 ⁻³	9.84×10 ⁻⁴
	metric slug	346	21.6	9.81	1	0.671	0.0108	9.80×10 ⁻³	9.62×10 ⁻³
	slug	515	32.2	14.6	1.49	1	0.0161	0.0146	0.0144
	short ton	3.20×10 ⁴	2000	907	92.5	62.2	1	0.909	0.893
	metric ton	3.53×10 ⁴	2205	1000	102	68.5	1.1	1	0.98
	long ton	3.58×10 ⁴	2240	1016	104	69.6	1.12	1.02	1

3.7 Density

		Convert To, Multiply By:					
		pounds per cubic inch (lbs/in ³)	pounds per cubic foot (lbs/ft ³)	pounds per gallon (lbs/gal)	grams per cubic centimeter (g/cm ³)	grams per cubic millimeter (g/mm ³)	grams per liter (g/L)
Convert From	pounds per cubic inch (lb/in ³)	1	1727	231	27.7	0.0277	2.77×10 ⁴
	pounds per cubic feet (lb/ft ³)	5.79×10 ⁻⁴	1	0.134	0.0160	1.60×10 ⁻⁵	16
	pounds per gallon (lb/gal)	4.33×10 ⁻³	7.48	1	0	0.0001	120
	grams per cubic centimeter (g/cm ³)	3.61×10 ⁻²	62.4	8.35	1	1000	1000
	grams per cubic millimeter (g/mm ³)	36.1	6.20×10 ⁴	8350	1×10 ⁻³	1	1×10 ⁻⁶
	grams per liter (g/L)	3.61×10 ⁻⁵	6.24×10 ⁻²	8.35×10 ⁻³	0.001	1×10 ⁶	1

3.8 Force

		Convert To, Multiply By:			
		dynes	newtons (N)	poundforce (lbf)	kilogramforce (kgf)
Convert From	dynes	1	1×10 ⁻⁵	2.25 ×10 ⁻⁶	1.02×10 ⁻⁶
	newtons (N)	1×10 ⁵	1	0.225	0.102
	poundforce (lbf)	4.45×10 ⁵	4.45	1	0.454
	kilogramforce (kgf)	9.81×10 ⁵	9.81	2.21	1

3.9 Mass

		Convert To, Multiply By:							
		ounce	pound	kilogram	metric slug	slug	short ton	metric ton	long ton
Convert From	ounce	1	0.0625	0.0283	2.89×10^{-3}	1.94×10^{-3}	3.13×10^{-5}	2.83×10^{-5}	2.79×10^{-5}
	pound	16.0	1	0.452	0.0463	0.0311	5.00×10^{-4}	4.54×10^{-4}	4.46×10^{-4}
	kilogram	35.3	2.21	1	0	0.0685	1.10×10^{-3}	1×10^{-3}	9.84×10^{-4}
	metric slug	346	21.6	9.81	1	0.671	0.0108	9.80×10^{-3}	9.62×10^{-3}
	slug	515	32.2	14.6	1.49	1	0.0161	0.0146	0.0144
	short ton	3.20×10^4	2000	907	92.5	62.2	1	0.909	0.893
	metric ton	3.53×10^4	2205	1000	102	68.5	1.1	1	0.98
	long ton	3.58×10^4	2240	1016	104	69.6	1.12	1.02	1

3.10 Energy

		Convert To, Multiply By:					
		British thermal unit (BTU)	foot-pound (ft-lb)	horsepower-hour (hp-hr)	joules (J)	calorie (C)	kilowatt-hour (kW-hr)
Convert From	British thermal unit (BTU)	1	0.0625	0.0283	2.89×10^{-3}	1.94×10^{-3}	3.13×10^{-5}
	foot-pound (ft-lb)	16.0	1	0.452	0.0463	0.0311	5.00×10^{-4}
	horsepower-hour (hp-hr)	35.3	2.21	1	0	0.0685	1.10×10^{-3}
	joules (J)	346	21.6	9.81	1	0.671	0.0108
	calorie (C)	515	32.2	14.6	1.49	1	0.0161
	kilowatt-hour (kW-hr)	3.58×10^4	2240	1016	104	69.6	1.12

3.11 Velocity

		Convert To, Multiply By:			
		feet per seconds (ft/s)	miles per hour (mph)	meters per second (m/s)	kilometers per hour (km/hr)
Convert From	feet per seconds (ft/s)	1	0.0625	0.0283	2.89×10^{-3}
	miles per hour (mph)	16.0	1	0.452	0.0463
	meters per second (m/s)	35.3	2.21	1	0
	kilometers per hour (km/hr)	3.58×10^4	2240	1016	104

3.12 Flow Rate

		Convert To, Multiply By:			
		gallons per minute (GPM)	cubic feet per second (ft ³ /s)	liters per second (L/s)	cubic meters per hour (m ³ /hr)
Convert From	gallons per minute (GPM)	1	0.0625	0.0283	2.89×10^{-3}
	cubic feet per second (ft ³ /s)	16.0	1	0.452	0.0463
	liters per second (L/s)	35.3	2.21	1	0
	cubic meters per hour (m ³ /hr)	3.58×10^4	2240	1016	104

3.13 Pressure

		Convert To, Multiply By:						
		pounds per square inch (psi)	atmo- spheres (atm)	kilograms per square meter (kg/m ²)	feet of water (68°F)	milli- meters of mercury (32°F)	bars (bar)	mega Pascals (MPa)
Convert From	pounds per square inch (psi)	1	0.0680	703	2.31	51.8	0.0690	6897
	atmospheres (atm)	14.7	1	1.03×10 ⁴	34.0	760	1.01	1.01×10 ⁵
	kilograms per square meter (kg/m ²)	1.42×10 ⁻³	9.68×10 ⁻⁵	1	3.29×10 ⁻³	0.0735	9.80×10 ⁻⁵	9.80
	feet of water (68°F)	0.433	0.0295	304	1	22.4	0.0298	2984
	millimeters of mercury (32°F)	1.93×10 ⁻²	1.32×10 ⁻³	13.6	0.0447	1	1.33×10 ⁻³	133
	bars	14.5	0.987	1.02×10 ⁴	33.5	750	1	1×10 ⁵
	megaPascals (MPa)	1.45×10 ⁻⁴	9.87×10 ⁻⁶	0.102	3.35×10 ⁻⁴	7.50×10 ⁻³	1×10 ⁻⁵	1

Worldwide at home

Our sales companies and representatives ensure local customer support in more than 100 countries.

www.gfps.com

Argentina / Southern South America

Georg Fischer Central Plastics
Sudamérica S.R.L.
Buenos Aires / Argentina
+54 11 4512 02 90
gfccentral.ps.ar@georgfischer.com
www.gfps.com/ar

Australia

George Fischer Pty. Ltd.
Riverwood NSW 2210
+61 (0) 2 9502 8000
australia.ps@georgfischer.com
www.gfps.com/au

Austria

Georg Fischer Rohrleitungssysteme GmbH
3130 Herzogenburg
+43 (0) 2782 856 43-0
austria.ps@georgfischer.com
www.gfps.com/at

Belgium / Luxembourg

Georg Fischer NV/SA
1600 Sint-Pieters-Leeuw / Belgium
+32 (0) 2 556 40 20
be.ps@georgfischer.com
www.gfps.com/be

Brazil

Georg Fischer Sist. de Tub. Ltda.
04571-020 São Paulo/SP
+55 (0) 11 5525 1311
br.ps@georgfischer.com
www.gfps.com/br

Canada

Georg Fischer Piping Systems Ltd.
Mississauga, ON L5T 2B2
+1 (905) 670 8005
ca.ps@georgfischer.com
www.gfps.com/ca

China

Georg Fischer Piping Systems Ltd.
Shanghai 201319
+86 21 3899 3899
china.ps@georgfischer.com
www.gfps.com/cn

Denmark / Iceland

Georg Fischer A/S
2630 Taastrup / Denmark
+45 (0) 70 22 19 75
info.dk.ps@georgfischer.com
www.gfps.com/dk

Finland

Georg Fischer AB
01510 Vantaa
+358 (0) 9 586 58 25
info.fi.ps@georgfischer.com
www.gfps.com/fi

France

Georg Fischer SAS
95932 Roissy Charles de Gaulle Cedex
+33 (0) 1 41 84 68 84
fr.ps@georgfischer.com
www.gfps.com/fr

Germany

Georg Fischer GmbH
73095 Albershausen
+49 (0) 7161 302 0
info.de.ps@georgfischer.com
www.gfps.com/de

India

Georg Fischer Piping Systems Pvt. Ltd.
400 083 Mumbai
+91 22 4007 2000
branchoffice@georgfischer.com
www.gfps.com/in

Indonesia

PT Georg Fischer Indonesia
Karawang 41371, Jawa Barat
+62 267 432 044
indonesia.ps@georgfischer.com
www.gfps.com/id

Italy

Georg Fischer S.p.A.
20864 Agrate Brianza (MB)
+39 02 921 86 1
it.ps@georgfischer.com
www.gfps.com/it

Japan

Georg Fischer Ltd.
530-0003 Osaka
+81 (0) 6 6341 2451
jp.ps@georgfischer.com
www.gfps.com/jp

Korea

Georg Fischer Korea Co. Ltd.
Unit 2501, U-Tower
120 Heungdeok Jungang-ro
(Yeongdeok-dong)
Giheung-gu, Yongin-si, Gyeonggi-do
+82 31 8017 1450
kor.ps@georgfischer.com
www.gfps.com/kr

Malaysia

Georg Fischer (M) Sdn. Bhd.
41200 Klang, Selangor Darul Ehsan
+60 (0) 3 3122 5585
my.ps@georgfischer.com
www.gfps.com/my

Mexico / Northern Latin America

Georg Fischer S.A. de C.V.
CP 66636 Apodaca, Nuevo Leon / Mexico
+52 (81) 1340 8586
mx.ps@georgfischer.com
www.gfps.com/mx

Middle East

Georg Fischer Piping Systems
(Switzerland) Ltd.
Dubai / United Arab Emirates
+971 4 289 49 60
gcc.ps@georgfischer.com
www.gfps.com/int

Netherlands

Georg Fischer N.V.
8161 PA Epe
+31 (0) 578 678 222
nl.ps@georgfischer.com
www.gfps.com/nl

New Zealand

Georg Fischer Ltd.
5018 Upper Hutt
+04 527 9813
nz.ps@georgfischer.com
www.gfps.com/nz

Norway

Georg Fischer AS
1351 Rud
+47 67 18 29 00
no.ps@georgfischer.com
www.gfps.com/no

Philippines

Georg Fischer Pte. Ltd.
Philippines Representative Office
1500 San Juan City
+632 571 2365
sgp.ps@georgfischer.com
www.gfps.com/sg

Poland

Georg Fischer Sp. z o.o.
05-090 Sekocin Nowy
+48 (0) 22 31 31 0 50
poland.ps@georgfischer.com
www.gfps.com/pl

Romania

Georg Fischer Piping Systems
(Switzerland) Ltd.
020257 Bucharest - Sector 2
+40 (0) 21 230 53 80
ro.ps@georgfischer.com
www.gfps.com/int

Russia

Georg Fischer Piping Systems
(Switzerland) Ltd.
Moscow 125040
+7 495 748 11 44
ru.ps@georgfischer.com
www.gfps.com/ru

Singapore

George Fischer Pte. Ltd.
528 872 Singapore
+65 6747 0611
sgp.ps@georgfischer.com
www.gfps.com/sg

Spain / Portugal

Georg Fischer S.A.
28046 Madrid / Spain
+34 (0) 91 781 98 90
es.ps@georgfischer.com
www.gfps.com/es

Sweden

Georg Fischer AB
117 43 Stockholm
+46 (0) 8 506 775 00
info.se.ps@georgfischer.com
www.gfps.com/se

Switzerland

Georg Fischer Rohrleitungssysteme
(Schweiz) AG
8201 Schaffhausen
+41 (0) 52 631 3026
ch.ps@georgfischer.com
www.gfps.com/ch

Taiwan

Georg Fischer Co. Ltd.
San Chung Dist., New Taipei City
+886 2 8512 2822
www.gfps.com/tw

United Kingdom / Ireland

Georg Fischer Sales Ltd.
Coventry, CV2 2ST / United Kingdom
+44 (0) 2476 535 535
uk.ps@georgfischer.com
www.gfps.com/uk

USA / Caribbean

Georg Fischer LLC
92618 Irvine, CA / USA
+1 714 731 8800
us.ps@georgfischer.com
www.gfps.com/us

Vietnam

George Fischer Pte Ltd.
Representative Office
Ho Chi Minh City
+ 84 28 3948 4000
sgp.ps@georgfischer.com
www.gfps.com/vn

International

Georg Fischer Piping Systems
(Switzerland) Ltd.
8201 Schaffhausen / Switzerland
+41 (0) 52 631 3003
info.export@georgfischer.com
www.gfps.com/int

The information and technical data (altogether "Data") herein are not binding, unless explicitly confirmed in writing. The Data neither constitutes any expressed, implied or warranted characteristics, nor guaranteed properties or a guaranteed durability. All Data is subject to modification. The General Terms and Conditions of Sale of Georg Fischer Piping Systems apply.