

JRG Valves

JRGURED UP

Pressure reducer $\frac{3}{4}$ "
Technical Documentation



JRGURED UP Pressure reducer

Compact and easy maintenance

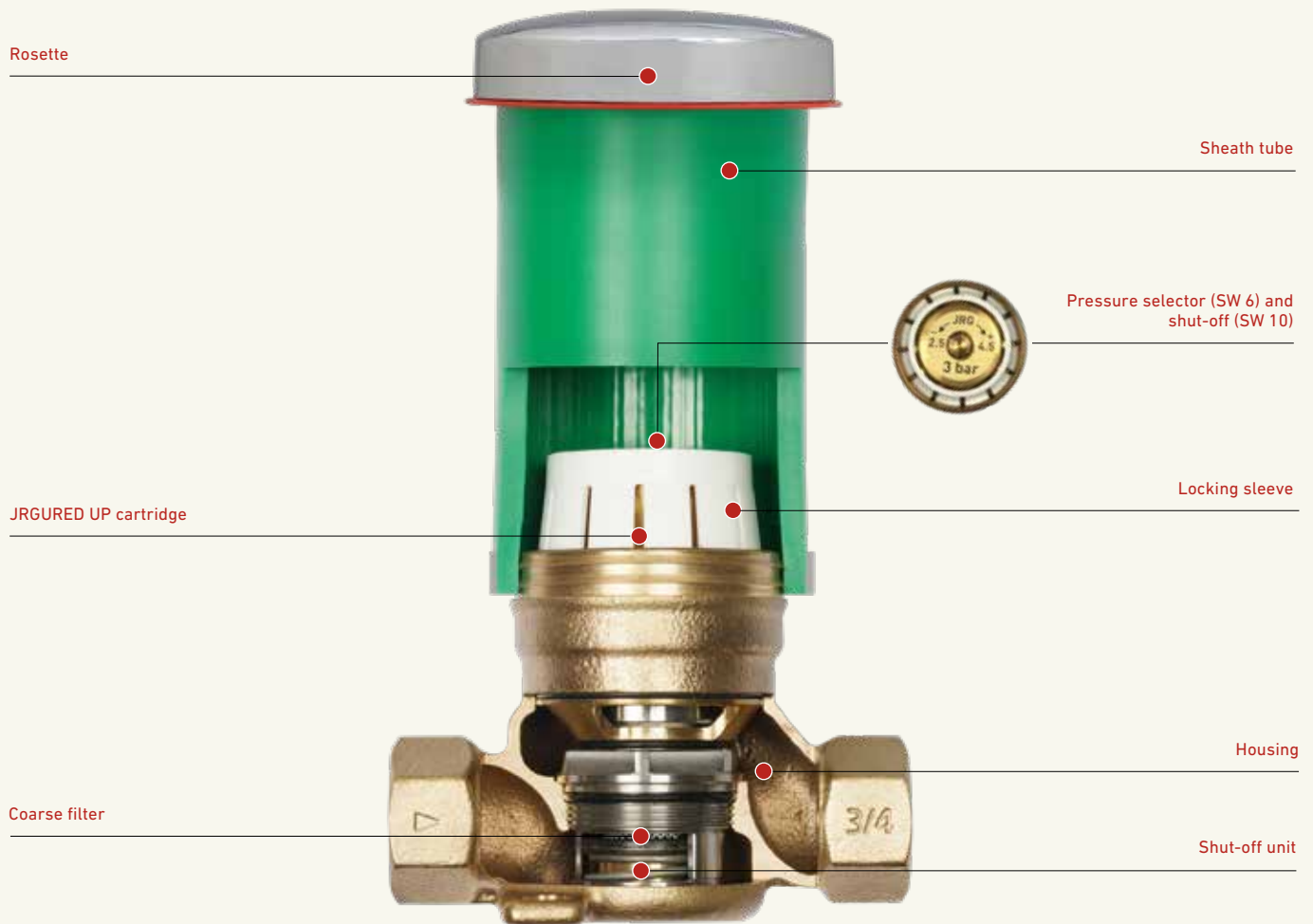

The JRGURED UP pressure reducer is a compact valve for drinking water installations, consisting of maintenance shut-off, coarse filter and pressure reducer. The coarse filter integrated into the JRGURED UP before the pressure reducer traps particulate matter greater than 1'000 µm. The valve should be annually serviced and the coarse filter cleaned.

The compact JRGURED UP pressure reducer is meant to be installed in wall-hung elements, which facilitates direct mounting onto mounting rails (such as JRG Code 5458.000 fitting plates for GIS profile and JRG Code 5459.000 mounting plate for Duofix wash basin element).

The sophisticated maintenance opening was designed following aesthetic guidelines.

The JRGURED UP pressure reducer is designed for a nominal pressure of 1'600 kPa (16 bar) and is factory set at 300 kPa (3 bar). The pressure settings ranging from 250 to 450 kPa (2.5-4.5 bar) can easily be adjusted on site by a qualified plumber. The valve is suitable for temperatures up to 70°C, respectively up to 90°C for short periods during thermal disinfection.

Approved by SVGW

Mounting Position

The JRGURED UP pressure reducer works in any position. Install the JRGURED UP pressure reducer free of stress so that the maintenance opening can easily be accessed.

Installation Instructions

When installing the JRGURED UP pressure reducer, local guidelines, regulations and standards must be observed.

Allen key size (SW):

Maintenance shut-off	10 mm
Pressure change	6 mm

A 360-degree turn of the key corresponds to a change in pressure of about 30 kPa (0.3 bar).

Area of Application

The JRGURED UP pressure reducer is approved for the following parameters:

JRG Code	PN	p_{sek}	Factory setting	t_{max}^*
1380.320	1'600 kPa (16 bar)	250-450 kPa (2.5-4.5 bar)	300 kPa (3 bar)	70°C

* Temperatures up to 90°C permissible for short periods during thermal disinfection.

+ Benefits

- Ultra-compact design
- Very small and sophisticated maintenance opening
- Round maintenance opening similar to the one of UP straight valves (same design of rosette)
- Installation depth for dry construction elements, optimized for Duofix / GIS

Comparison example JRGURED UP / conventional

System with JRGURED UP installed

Pressure stage 1

Pressure reduced by booster station before each floor distributor.

The JRGURED UP provides for smaller riser shafts and faster installation of the risers.

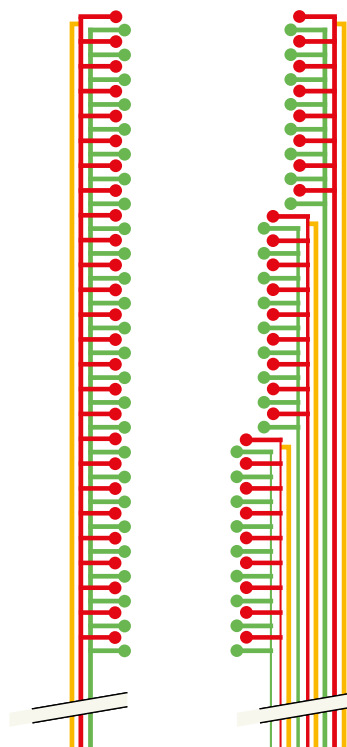

Conventional system

Pressure stage 3

Pressure not reduced by booster station.

Pressure stage 2

Pressure reduced by booster station.

Pressure stage 1

Pressure from mains reduced if necessary.

Nomogram JRGURED UP pressure reducer DN20 with cartridge installed

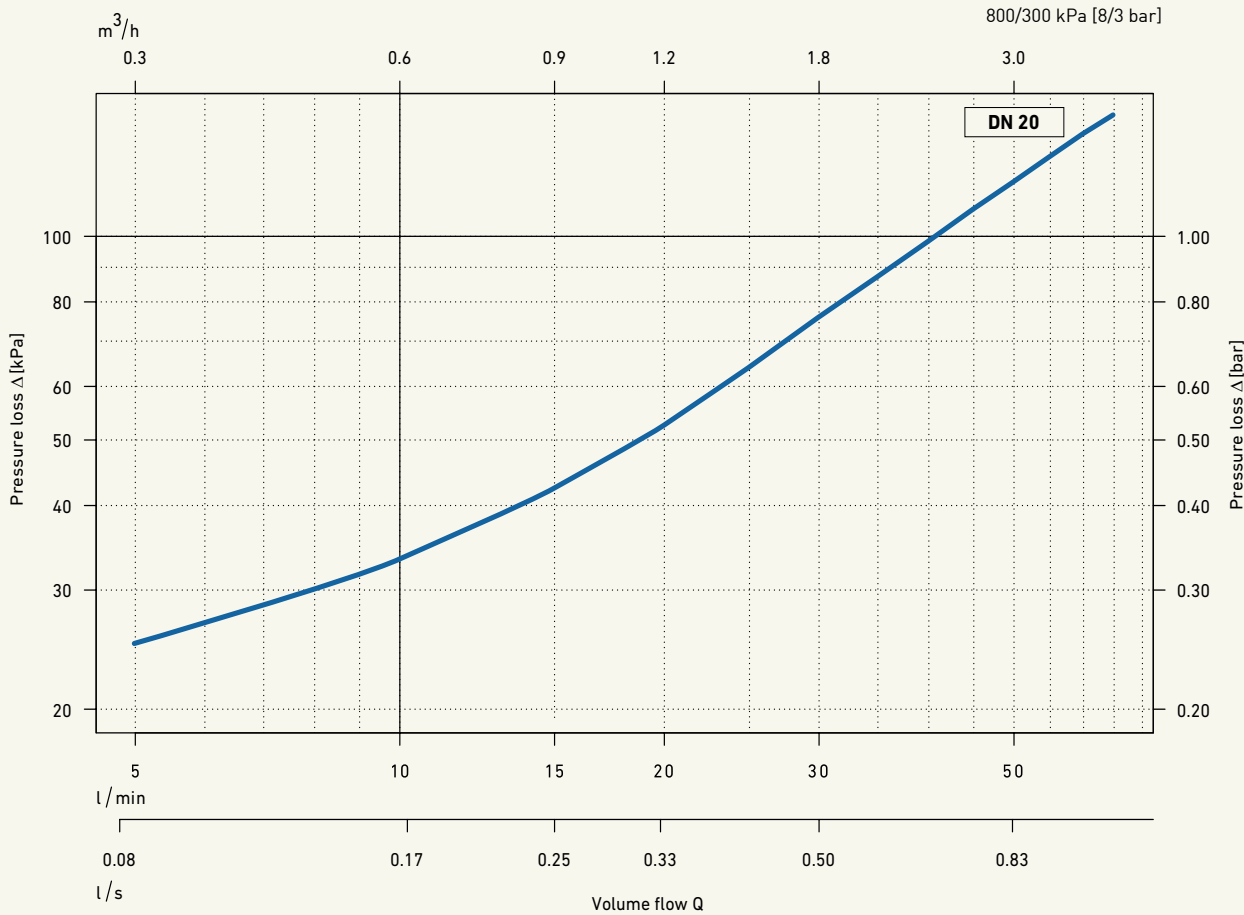

Nomogram JRGURED UP pressure reducer DN20 with by-pass plug

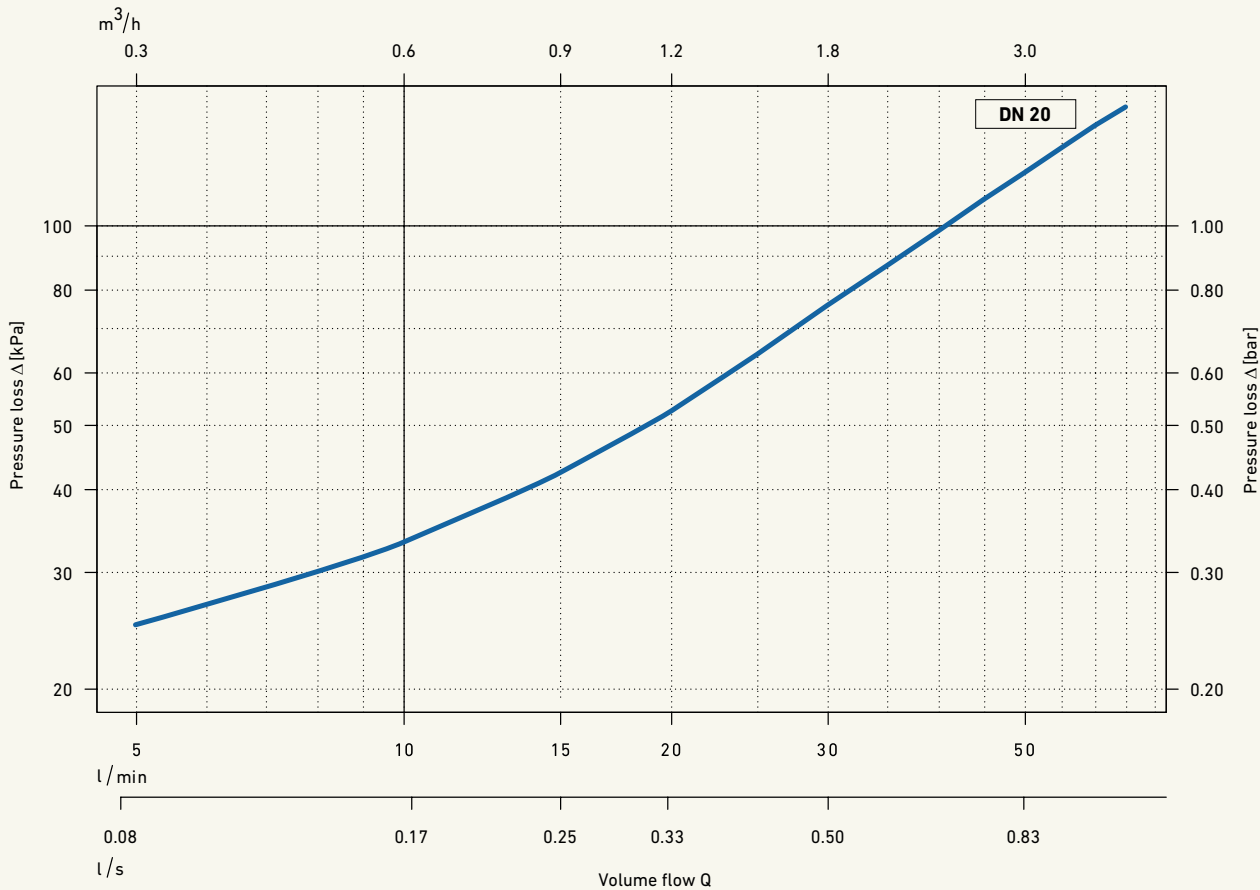

JRGURED UP Pressure reducer

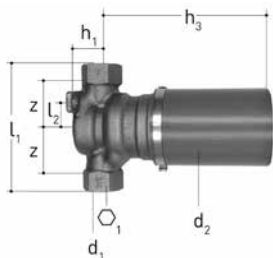

Pre-installation set JRGURED UP DN 20, PN 16

With female thread, body made of gunmetal, stainless steel seat, EPDM valve seal, plastic sheath tube.

For water up to 70°C (short-term 90°C).

Rear mounting set for flange see Item No. 5929.001

JRGURED UP cartridge see Item No. 1381.320.

JRGURED UP rosette see Item No. 1383.320.

GN	DN	JRG	GF	Weight
(inch)	(mm)	Code	Code	(kg)
3/4	20	1380.001	350 739 016	0.980

GN	DN	d1 Rp	d2	h1	h3	l1	l2	z	⊘
(inch)	(mm)	(inch)	(mm)	(mm)	(mm)	(mm)	(mm)	(mm)	
3/4	20	3/4	66	22	64 - 154	110	22	41	32

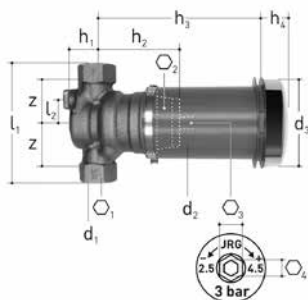

JRGURED UP pressure reducer DN 20, PN 16 - 3 bar

With female thread, body made of gunmetal, stainless steel gate and seat, EPDM membrane and valve seal, strainer made of stainless steel 1'000 µm, plastic sheath tube, rosette made of chrome-plated plastic.

For water up to 70°C (short-term 90°C).

Factory setting at 300 kPa (3 bar), adjustment range 250-450 kPa (2.5-4.5 bar).

Rear mounting set for flange see Item No. 5929.001

GN	DN	JRG	GF	Weight
(inch)	(mm)	Code	Code	(kg)
3/4	20	1380.320	350 739 001	1.480

GN	DN	d1 Rp	d2	d3	h1	h2	h3	h4	l1	l2	z	⊘1	⊘2	⊘3	⊘4
(inch)	(mm)	(inch)	(mm)	(mm)	(mm)	(mm)	(mm)	(mm)	(mm)	(mm)	(mm)	(mm)	(mm)	(mm)	(mm)
3/4	20	3/4	66	80	22	78	64 - 154	23	110	22	41	32	36	10	6

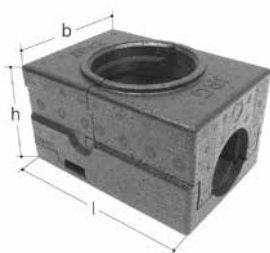

Insulation box for JRGURED UP 1380

Made of EPP, thermal conductivity 0.047 W/mK

l	b	h	JRG	GF	Weight
(mm)	(mm)	(mm)	Code	Code	(kg)
120	82	70	1388.320	350 739 095	0.032

Accessories and spare parts



JRGURED UP cartridge DN 20, PN 16 - 3 bar

Suitable for JRGURED UP 1380.320
 Made of gunmetal, stainless steel gate and seat, EPDM membrane and valve seal, strainer made of stainless steel 1'000 µm, plastic locking sleeve.
 For water up to 70°C (short-term 90°C).
 Factory setting at 300 kPa (3 bar), adjustment range 250-450 kPa (2.5-4.5 bar).

GN (inch)	DN (mm)	JRG Code	GF Code	Weight (kg)	d1 (mm)	d2 (mm)	h1 (mm)	○1	○2	○3
¾	20	1381.320	350 739 084	0.560	M52 x 1.5 L	29	83	36	10	6



JRGURED UP Shut-off Unit DN 20

Suitable for JRGURED UP 1380.320
 Made of stainless steel, EPDM valve seal.
 For water up to 70°C (short-term 90°C).

GN (inch)	DN (mm)	JRG Code	GF Code	Weight (kg)	d1 (mm)	h1 (mm)	○1
¾	20	1382.320	350 739 081	0.093	M36 x 1.5	33	36



JRGURED UP Rosette

Suitable for JRGURED UP 1380.320, made of chrome-plated plastic, media markers blue/red.

GN (inch)	DN (mm)	JRG Code	GF Code	Weight (kg)	d1 (mm)	d2 (mm)	h1 (mm)
¾	20	1383.320	350 739 082	0.045	80	83	22



JRGURED UP By-pass Plug

Suitable for JRGURED UP 1380.320, made of plastic, plastic locking sleeve. For water up to 70°C (short-term 90°C).

GN (inch)	DN (mm)	JRG Code	GF Code	Weight (kg)	d1 (mm)	h1 (mm)	h2 (mm)	○1
¾	20	1384.320	350 739 080	0.065	M52 x 1.5 L	68	83	27

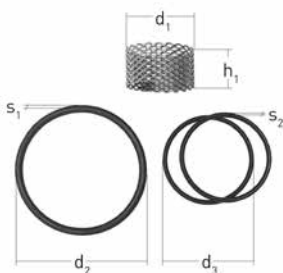

JRGURED UP Spare Part Set

Suitable for JRGURED UP cartridge 1381.320, consisting of coarse filter Inox 1'000 µm, EPDM O-rings.

GN (inch)	DN (mm)	JRG Code	GF Code	d1 (mm)	d2 (mm)	S1 (mm)	d3 (mm)	S2 (mm)	d5 (mm)	h1 (mm)
¾	20	1385.320	350 739 083	20	45.52	2.62	25.12	1.68	1.68	12

Accessories and spare parts



JRGURED UP Locking Sleeve

Suitable for JRGURED UP 1380.320, made of plastic.

GN (inch)	DN (mm)	JRG Code	GF Code	Weight (kg)	d1 (mm)	h1 (mm)	d2 (mm)
¾	20	1386.320	350 739 086	0.015	55	44	27

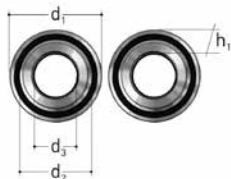

JRGURED UP Test Adapter Set

Suitable for JRGURED UP 1380.320, made of gunmetal, two-piece set.

GN (inch)	DN (mm)	JRG Code	GF Code	Weight (kg)	d1 (mm)	d2 (mm)	d3 (mm)	h1 (mm)
¾	20	1387.320	350 739 088	0.090	40	28	19	10

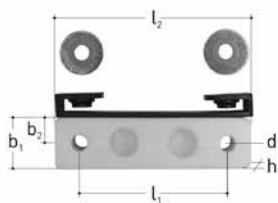

Spacer

Suitable for JRGURED UP 1380.320, concealed straight valves, concealed shut-off valves and JRG LegioStop shut-off units, made of plastic.

GN (inch)	DN (mm)	JRG Code	GF Code	Weight (kg)	d (mm)	h (mm)	l1 (mm)	l2 (mm)	b1 (mm)	b2 (mm)
¾	20	1389.320	350 739 097	0.055	6	20	60	80	20	10

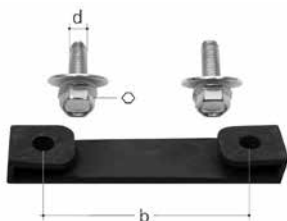

Fixing set for rear

For the mounting of concealed valves with fixing flange consisting of: Noise absorbing plate 60° Shore A, Self tapping fixing screws, washer and dished spring suitable to: 1380.320, 5900, 5909, 5910, 5916, 5922, 5924, 5925, 5458.045, 5458.055

d (mm)	JRG Code	GF Code	Weight (kg)	b (mm)	⊙1
M6	5929.001	351 062 088	0.025	60	10



JRGURED UP Installation Tool

Suitable for JRGURED UP 1380.320, made of steel, including two test adapters made of gunmetal 1387.320.

GN (inch)	DN (mm)	JRG Code	GF Code	Weight (kg)	d1 (mm)	d2 (mm)	d3 (mm)	l1 (mm)	l2 (mm)	⊙1 (mm)
¾	20	8140.000	350 739 090	1.460	48	45	12	240	260	36

Worldwide at home

Our sales companies and representatives ensure local customer support in over 100 countries.

www.gfps.com

Argentina / Southern South America

Georg Fischer Central Plastics Sudamérica S.R.L.
Buenos Aires, Argentina
Phone +54 11 4512 02 90
Fax +54 11 4512 02 93
gfcentral.ps.ar@georgfischer.com
www.gfps.com/ar

Australia

George Fischer Pty Ltd
Riverwood NSW 2210
Phone +61 (0) 2 9502 8000
Fax +61 (0) 2 9502 8090
australia.ps@georgfischer.com
www.gfps.com/au

Austria

Georg Fischer Rohrleitungssysteme GmbH
3130 Herzogenburg
Phone +43 (0) 2782 856 43 0
Fax +43 (0) 2782 856 64
austria.ps@georgfischer.com
www.gfps.com/at

Belgium / Luxembourg

Georg Fischer NV/SA
1600 Sint-Pieters-Leeuw / Belgium
Phone +32 (0) 2 556 40 20
Fax +32 (0) 2 524 34 26
be.ps@georgfischer.com
www.gfps.com/be

Brazil

Georg Fischer Sist. de Tub. Ltda.
04571-020 São Paulo/SP
Phone +55 (0) 11 5525 1311
br.ps@georgfischer.com
www.gfps.com/br

Canada

Georg Fischer Piping Systems Ltd
Mississauga, ON L5T 2B2
Phone +1 (905) 670 8005
Fax +1 (905) 670 8513
ca.ps@georgfischer.com
www.gfps.com/ca

China

Georg Fischer Piping Systems Ltd
201319 Shanghai
Phone +86 21 3899 3899
Fax +86 21 3899 3888
china.ps@georgfischer.com
www.gfps.com/cn

Denmark / Iceland

Georg Fischer A/S
2630 Taastrup, Denmark
Phone +45 (0) 7022 1975
Fax +45 (0) 7022 1976
info.dk.ps@georgfischer.com
www.gfps.com/dk

Finland

Georg Fischer AB
01510 Vantaa
Phone +358 (0) 9 586 58 25
Fax +358 (0) 9 586 58 29
info.fi.ps@georgfischer.com
www.gfps.com/fin

France

Georg Fischer SAS
95932 Roissy Charles de Gaulle Cedex
Phone +33 (0) 1 41 84 68 84
Fax +33 (0) 1 41 84 68 85
fr.ps@georgfischer.com
www.gfps.com/fr

Germany

Georg Fischer GmbH
73095 Albershausen
Phone +49 (0) 7161 302 0
Fax +49 (0) 7161 302 25 9
info.de.ps@georgfischer.com
www.gfps.com/de

India

Georg Fischer Piping Systems Pvt. Ltd.
400 076 Powai, Mumbai
Phone +91 22 4007 2000
Fax +91 22 4007 2020
branchoffice@georgfischer.com
www.gfps.com/in

Indonesia

George Fischer Pte Ltd
41371 Jawa Barat
Phone +62 267 432 044
Fax +62 267 431 857
indonesia.ps@georgfischer.com
www.gfps.com/id

Italy

Georg Fischer S.p.A.
20063 Cernusco S/N (MI)
Phone +39 02 921 86 1
Fax +39 02 921 86 24 7
it.ps@georgfischer.com
www.gfps.com/it

Japan

Georg Fischer Ltd
530-0003 Osaka
Phone +81 (0) 6 6341 2451
jp.ps@georgfischer.com
www.gfps.com/jp

Korea

Georg Fischer Piping Systems
463-824 Seoul
Phone +82 31 8017 1450 3
Fax +82 31 8017 1454
kor.ps@georgfischer.com
www.gfps.com/kr

Malaysia

George Fischer (M) Sdn. Bhd.
40460 Shah Alam, Selangor Darul Ehsan
Phone +60 (0) 3 5122 5585
Fax +60 (0) 3 5122 5575
my.ps@georgfischer.com
www.gfps.com/my

Mexico / Northern Latin America

Georg Fischer S.A. de C.V.
Apodaca, Nuevo Leon, Mexico
Phone +52 (81) 1340 8586
Fax +52 (81) 1522 8906
mx.ps@georgfischer.com
www.gfps.com/mx

Middle East

Georg Fischer Piping Systems (Switzerland) Ltd
Dubai, United Arab Emirates
Phone +971 4 289 49 60
Fax +971 4 289 49 57
gss.ps@georgfischer.com
www.gfps.com/int

Netherlands

Georg Fischer N.V.
8161 PA Epe
Phone +31 (0) 578 678 222
Fax +31 (0) 578 621 768
nL.ps@georgfischer.com
www.gfps.com/nl

New Zealand

Georg Fischer Ltd
5140 Upper Hutt
Phone +64 (0) 4 527 9813
Fax +64 (0) 4 527 9834
nz.ps@georgfischer.com
www.gfps.com/nz

Norway

Georg Fischer AS
1351 Rud
Phone +47 67 18 29 00
Fax +47 67 13 92 92
no.ps@georgfischer.com
www.gfps.com/no

Philippines

Georg Fischer Representative Office
1604 Pasig City
Phone +632 571 2365
Fax +632 571 2368
sgp.ps@georgfischer.com
www.gfps.com/sg

Poland

Georg Fischer Sp. z o.o.
05 090 Sekocin Nowy
Phone +48 (0) 22 3131 050
Fax +48 (0) 22 3131 060
poland.ps@georgfischer.com
www.gfps.com/pl

Romania

Georg Fischer Rohrleitungssysteme (Elvetia)
S.A. SUCURSALA BUCURESTI
020257 Bucuresti
Phone +40 311 040 492
Fax +40 212 317 479
ro.ps@georgfischer.com
www.gfps.com/int

Russia

Georg Fischer Piping Systems (Switzerland) Ltd
Moscow Representative Office
125040 Moscow
Phone +7 495 748 11 44
ru.ps@georgfischer.com
www.gfps.com/ru

Singapore

Georg Fischer Pte Ltd
528 872 Singapore
Phone +65 6747 0611
Fax +65 6747 05 77
sgp.ps@georgfischer.com
www.gfps.com/sg

Spain / Portugal

Georg Fischer S.A.
28046 Madrid
Phone +34 (0) 91 781 98 90
Fax +34 (0) 91 426 08 23
es.ps@georgfischer.com
www.gfps.com/es

Sweden

Georg Fischer AB
11743 Stockholm
Phone +46 (0) 8 506 77 50 0
Fax +46 (0) 8 749 23 70
info.se.ps@georgfischer.com
www.gfps.com/se

Switzerland

Georg Fischer Rohrleitungssysteme (Schweiz) AG
8201 Schaffhausen
Phone +41 (0)52 631 3026
Fax +41 (0)52 631 2800
ch.ps@georgfischer.com
www.gfps.com/ch

Taiwan

Georg Fischer Co. Ltd.
24158 New Taipei City
Phone +886 2 8512 2822
Fax +886 2 8512 2823
tw.ps@georgfischer.com
www.gfps.com/tw

Turkey

Georg Fischer Hakan Plastik
Boru ve Profil San. Tic. A.Ş.
59500 Cerkezkoy / Tekirdag
Phone +90 282 726 64 43
Fax +90 282 726 94 67
hpsales@hakan.com.tr
www.hakan.com.tr

United Kingdom / Ireland

Georg Fischer Sales Ltd
CV2 2ST Coventry, United Kingdom
Phone +44 (0) 2476 535 535
Fax +44 (0) 2476 530 450
uk.ps@georgfischer.com
www.gfps.com/uk

USA / Caribbean

Georg Fischer LLC
92618 Irvine
Phone +1 714 731 88 00
Fax +1 714 731 62 01
Toll Free 800/854 40 90
us.ps@georgfischer.com
www.gfps.com/us

International

Georg Fischer Piping Systems (Switzerland) Ltd
8201 Schaffhausen
Phone +41 (0) 52 631 3003
Fax +41 (0) 52 631 2893
info.export@georgfischer.com
www.gfps.com/int

The technical data are not binding. They neither constitute expressly warranted characteristics nor guaranteed properties nor a guaranteed durability. They are subject to modification. Our General Terms of Sale apply.

37 262 62

e / 10.18

© Georg Fischer JRG AG

Hauptstrasse 130

CH-4450 Sissach/Switzerland

Telefon +41 (0) 61 975 22 22

info.jrg.ps@georgfischer.com

Printed in Switzerland