

Built for the future

Butterfly Valve 565 Lug-Style





Defying industry challenges

The importance of water for humanity cannot be understated. At first glance, it looks like an easy thing to handle. However, this vital media poses various challenges to industries requiring sophisticated and robust piping systems to ensure safe and reliable operation.

Water is life, and water is the most used substance on Earth. Consequently, treating it with utmost care and the highest quality systems is crucial for the environment, industries, and humans. Water challenges vary for industries such as water treatment, marine, and cooling applications. They all need reliable yet cost-effective solutions. Global megatrends such as climate change, urbanization, and digitalization are additional challenges industries must consider.

Historically, when it comes to butterfly valves, metal was the material of choice. The robustness and economic efficiency were convincing arguments for choosing metal valves. As durable as they are, there are some crucial drawbacks.

First, metal suffers from corrosion and abrasion. Depending on the environment, this shortens the lifetime of the valve significantly, resulting in additional costs due to interruptions of operation and replacements for the old valves. Second, there is weight. Metal butterfly valves are heavy, increasing stresses on piping systems and leading to required supporting structures. Additionally, the heavy valves are cumbersome to install and maintain.

Those drawbacks are the foundation for the biggest challenge – sustainability and the ecological footprint. Lightweight and long-living components are key for reaching both mandatory and self-proclaimed sustainability goals.

Building the future with lightweight durability

As thermoplastics provide strength, durability, and resistance to corrosion, they have overtaken metal as the primary choice for industrial applications. The benefits of the durable material in industrial applications cannot be denied.

With the Butterfly Valve 565 Lug-Style, GF Piping Systems completes its portfolio of high-quality thermoplastic butterfly valves for water- and water treatment applications. Introduced in 2021, the success story of the 565 started with the launch of the Wafer-Style valve. The Butterfly Valve 565 Lug-Style now completes the portfolio, allowing for even more use cases.

Unlike a Wafer-Style valve, the Lug-Style valve can be used as an end valve thanks to the body design and threaded inserts. Therefore, piping systems can be disassembled one-sided, facilitating the maintenance and operation of filters, tanks, and other installations.

The thermoplastic solution flattens the path to a more sustainable future by being 60% lighter than metal competitors on average. Meanwhile, the expected service life is three times greater than metal valves in critical installations. With the latest innovation of the Butterfly Valve 565, GF Piping Systems can offer a more sustainable, robust, and cost-effective solution for the reliable control of fluids.

Thanks to the standard interface, the Butterfly Valve 565 can be easily equipped with different actuation possibilities, such as pneumatic, electric, and smart actuators, enabling automated processes and future-proof operation.





Superior performance

Superior in every way, our high-performance thermoplastic butterfly valve enables the safe and sustainable control of fluids for all your water applications.

Direct replacement

The Butterfly Valve 565 comes in the same installation length as metal solutions. The exchange does not require any additional work on the pipes or new designs. This reduces the effort of both planning and installation, also thanks to a lighter weight.

Highly reliable

The Butterfly Valve 565 is built to last. High-performance thermoplastics protect it from abrasion and corrosion. This guarantees a longer system lifetime, even under harsh conditions such as water hammers. The results are a reduction of both maintenance costs and production stops.

Swiss quality

The Butterfly Valve 565 is produced by GF Piping Systems in Seewis (Grisons), Switzerland. High-quality valves have been produced here for over half a century. They combine technological innovation with the highest standards of material selection, manufacturing, and quality testing for safety, durability, and reliability.

60% lighter

Thanks to its low weight, a single person can lift and install the Butterfly Valve 565 in just a few minutes. This allows for easier installation, since the low weight significantly reduces the need for costly transportation and personnel.

Reduced costs

With the initial cost being comparable to metal solutions, the Butterfly Valve 565 outperforms its metal counterparts in the long run, reducing maintenance and replacement costs thanks to its superior materials and design.

Ready for digitization

With its standard interface, the Butterfly Valve 565 can be upgraded with various modules, such as the smart actuator. This allows for automation and digitization of your systems, making them even more cost-effective and efficient.

Butterfly Valve 565 Lug-Style

Built for you

At GF Piping Systems, we understand that different challenges require adjustable solutions. This is why we revolutionized the well-proven design of lug-style butterfly valves. Adding plug-in lug inserts ensures the highest compatibility, flexibility, and increased sustainability.



Customizable and sustainable

The inserts are high-grade stainless steel as standard. Depending on individual requirements, the material can be changed to various materials on request. The removable inserts not only allow for the highest flexibility and customization but also for correctly sorted recycling at the end of service life, too.



Easier installation

Thermoplastic valves are on average 60% lighter than metal valves, making them easier to transport, handle, and install. Their lightweight design also reduces transportation and operation costs. The 565 comes in the same installation length (EN558 row 20, ISO 5752 row 20) as metal solutions facilitating the installation even more.



Inductive feedback sensor

The Butterfly Valve 565 is offered with inductive sensors that signal the CLOSED or OPEN position of the valve via an electric signal to a controller supplied by the customer. This feedback system can be added with the valve in-line and a new sensor swapped without removing the operator.

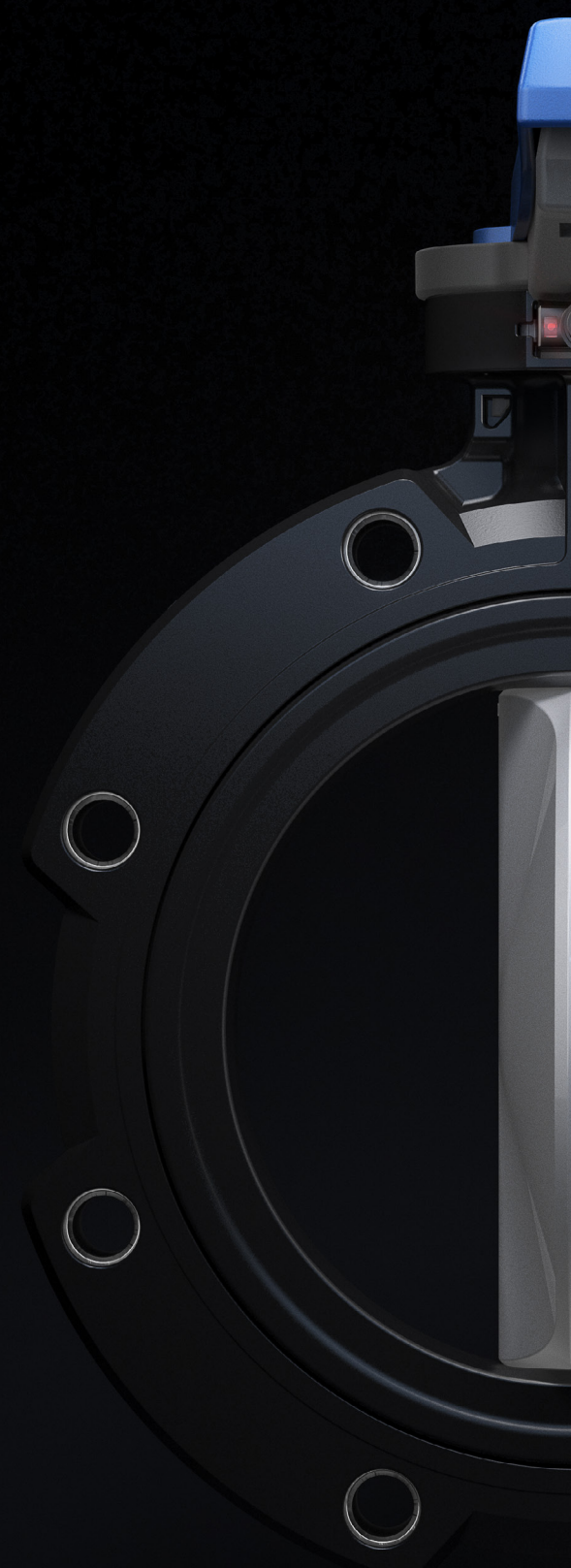

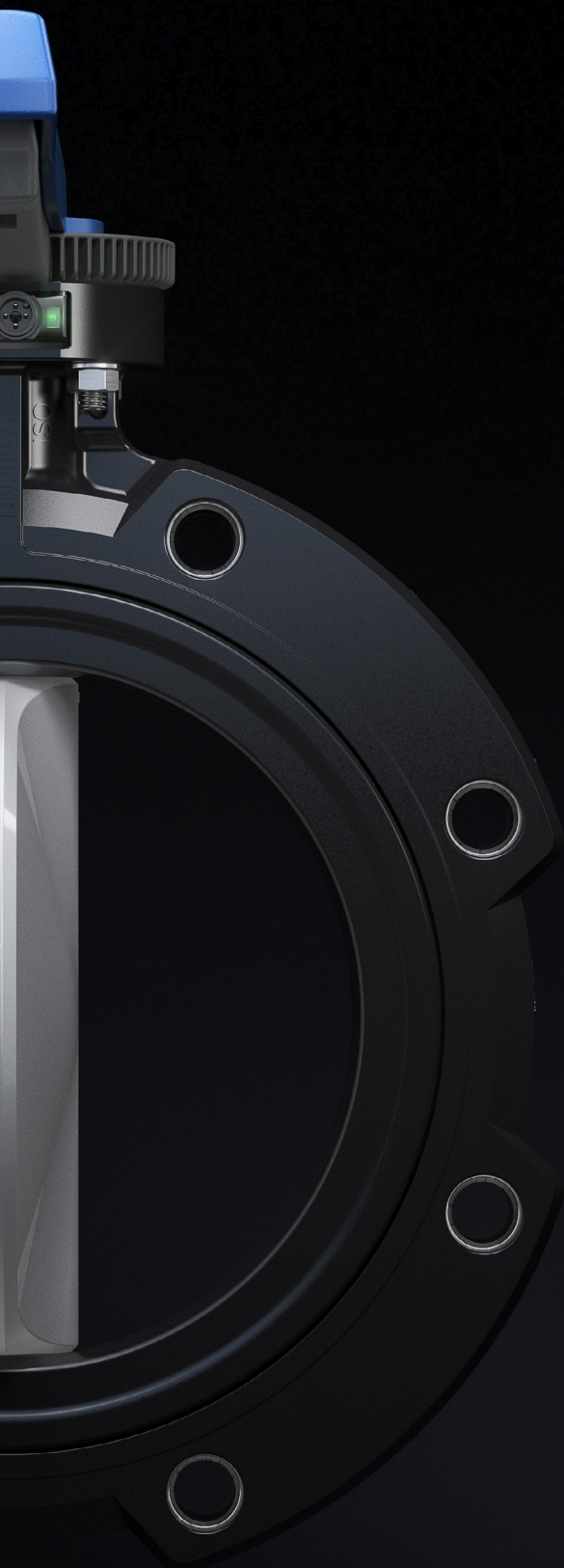

Unique and patented

The design of the valve housing is open at the side. The unique and patented design allows for easy access to the inserts. With this plug-in design of the inserts, less material is used than conventional solutions with over-molded inserts.



Better performance

Unlike metal valves, thermoplastic valves are immune to corrosion from rust and chemicals, which makes them ideal for use in harsh environments. They also have low thermal conductivity, which means they are better insulators than metal valves.



Full insight

The Data-Matrix-Code on the 565 simplifies the storage of all technical information for each valve, thus enabling individual traceability. The faultless identification of each valve facilitates easy installation, service, and repair.



Reinforced disc

The Butterfly Valve 565 has a unique and patented disc design. The inner disc is made of fiber-reinforced polyamide and is encapsulated with PVDF. This design strengthens the durability and pressure/temperature performance of the valve.

Engineered for the future

Superior longevity

Thermoplastic valves are highly durable and can last for many years without requiring replacement. They are also resistant to impact damage and can withstand extreme temperatures.

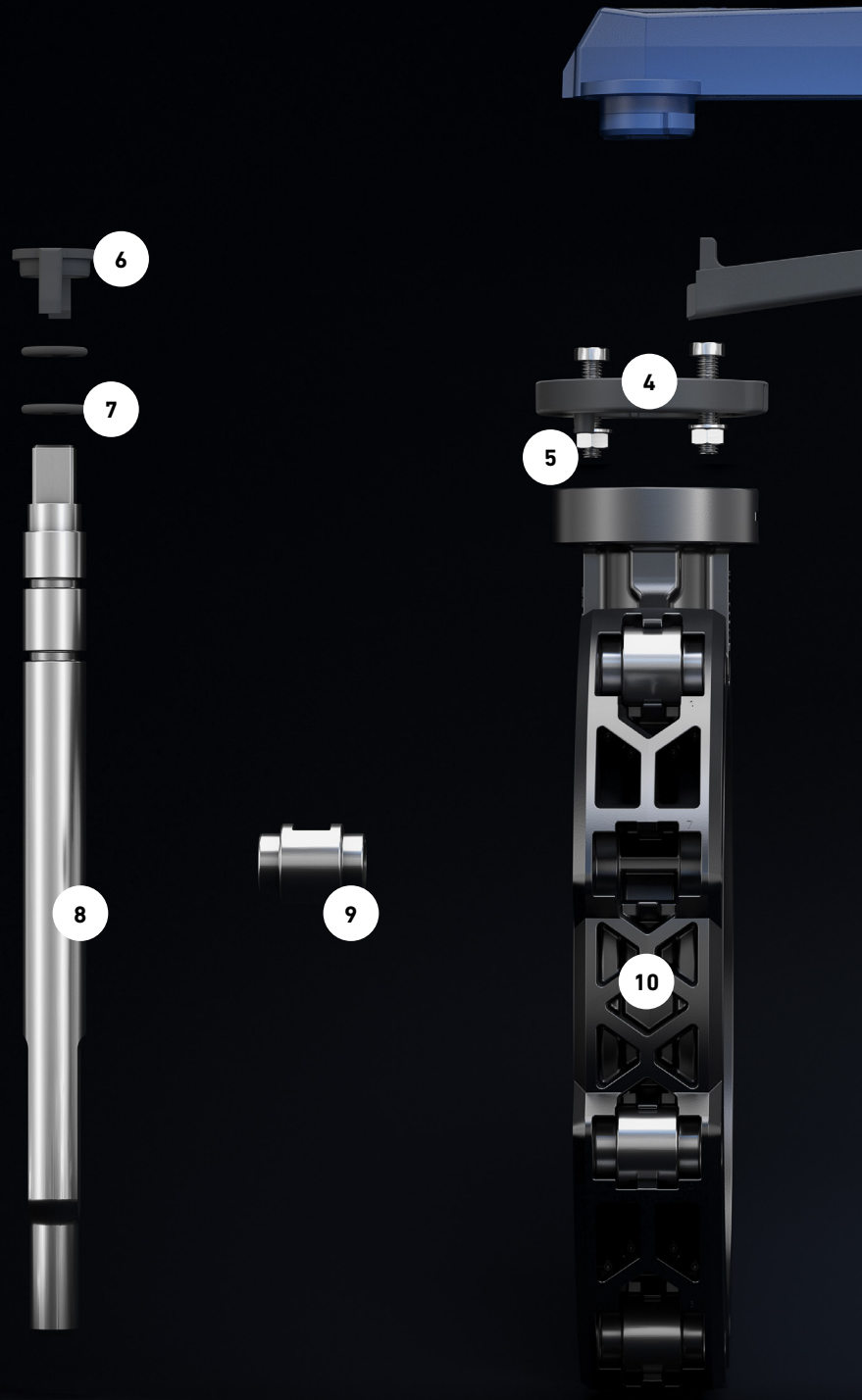

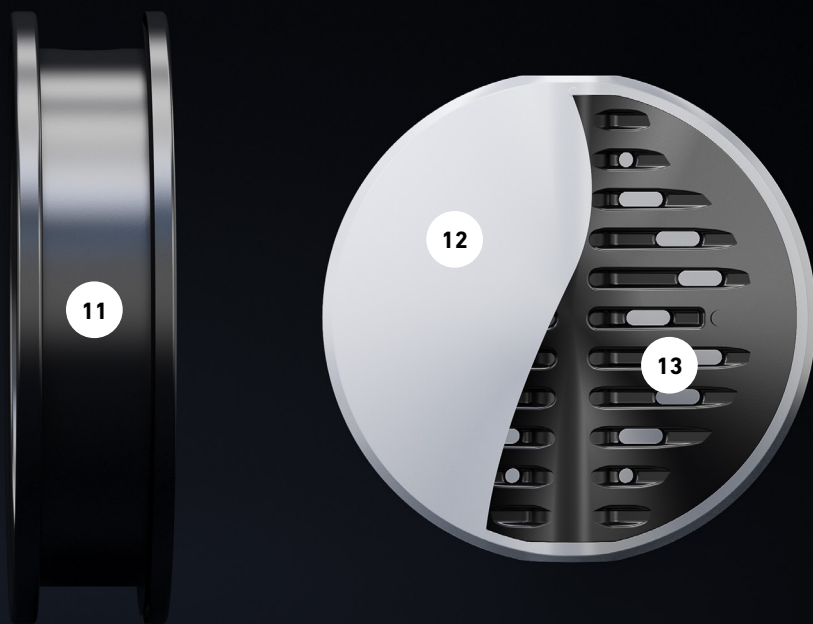
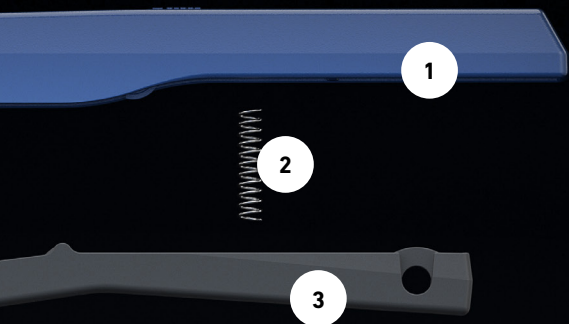

- 1. Lever
- 2. Spring
- 3. Grid lever
- 4. Index plate
- 5. Screw
- 6. Shaft lock
- 7. O-Ring
- 8. Shaft
- 9. Threaded inserts
- 10. Lug-style housing
- 11. Seat liner
- 12. Outer disc - PVDF
- 13. Inner disc - PA

Customizable modularity

Matching individual challenges



The Butterfly Valve 565 can be manually operated with a lockable lever or a hand wheel. Here, the effort required to fully open and close it can be reduced with the help of a gearbox. In addition, it can be operated with a pneumatic actuator that is ideal for plants with a high number of actuated valves, and an electric or smart actuator. But above all, the Butterfly Valve 565 features digital interfaces for state-of-the-art process automation.

Pneumatic Actuator

Pneumatic actuators are an economical solution for installations with many actuated valves. They are fast, adjustable, and have a fail-safe mode. The latest generation is entirely made from high-performance thermoplastics. Additionally, pneumatic actuators can be equipped with electro-pneumatic positioners, further increasing control and precision.



Electric Actuator

Electric actuators are highly reliable and easy to set up and operate. The latest generation introduces features such as Industrial Ethernet communication standards and an improved IP68 rating. The actuator can be installed on any standard valve with an ISO 5211 interface. Additional accessories allow the actuator to be used not only as an open/close actuator but also in continuously controlled operation.

Smart Actuator

Digitization is changing and improving many aspects of our lives. At GF Piping Systems, we are significantly shaping this progress by constantly developing our products. Our latest actuator is our first product that can be controlled fully by an app. Take the step with us into the future with our new digital actuator. One app, one actuator, many possibilities.

Customizable modularity



Accessories

Double Sensor for electrical position feedback

The LED position feedback allows the current position of the valve to be centrally recorded and checked at any time – for manually operated and automated valves. The compact dual-sensor fits even in the tightest areas and is protected against water and dust (protection class IP67).



Axle extension

Great versatility for increasingly complex water systems. Available in custom lengths up to DN300, the extension is ideal for applications where the valve is difficult for an operator to access. For manual versions, a lever or handwheel can be used. The extension is also suitable for applications where the valve is temporarily submerged. In such cases, the actuator is lifted from the submerged area, allowing operation and preventing damage.

Spare parts

- O-ring
- Seat liner
- Disc
- Shaft
- Condensation block

Leveraging superior qualities

More than half a century ago, GF Piping Systems decided to switch from metal to thermoplastic. This was both a revolutionary and a forward-looking step, as the disadvantages of metal have proven to be the advantages of thermoplastic. The Butterfly Valve 565 Lug-Style is the newest product of this innovation process, outperforming its metal counterparts in many ways.

Lightweight but robust. Thermoplastic tends to get a bad reputation in today's discussions. However, their superior material characteristics make them the ideal solution for the challenges that lie ahead.

The Butterfly Valve 565 Lug-Style offers numerous technical advantages. Its patented double-molded Polyamide disc coated with high-performance PVDF ensures exceptional strength, chemical resistance, and low friction. This makes the valve suitable for harsh environments and various industries.

Additionally, the valve's compact design and the short installation length compared to traditional metal valves, make it the perfect fit for confined spaces and retrofit installations. The short installation length, in accordance with ISO 5752, eliminates the need for costly reworks of existing piping systems, while the long-lasting and lightweight materials need no supporting structure. Hence, the Butterfly Valve 565 Lug-Style is the ideal choice for price-sensitive applications, too.

Another technical advantage of the product range extension is its compatibility with inductive double sensors and a switching ring. This sensor technology provides precise and reliable feedback on the valve's position and performance. By integrating these sensors, users can monitor and control the valve remotely, making it ideal for automation and remote operation systems. Additional accessories and the modular character allow for easy plug-and-play process automation.

Lastly, the unique and patented plug-in insert design allows for easy maintenance, servicing, and customization, reducing downtime and operational disruptions. Additionally, the removable metal inserts can be disassembled for correctly sorted recycling. Thus, further increasing the sustainability of the Butterfly Valve 565 Lug-Style.

Pressure-temperature diagrams*

EPDM (DN50 – DN300)

T Temperature (°C, °F)
P Permissible pressure (bar, psi)

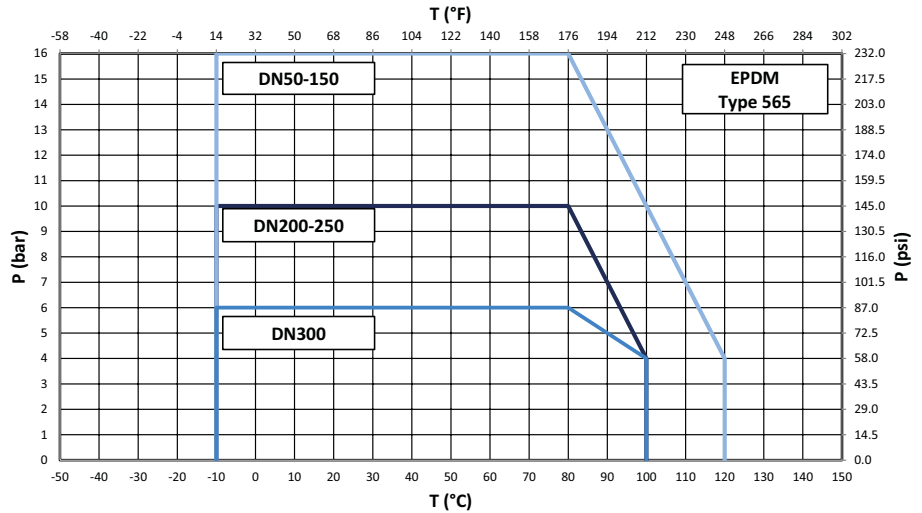

FKM (DN50 – DN300)

T Temperature (°C, °F)
P Permissible pressure (bar, psi)

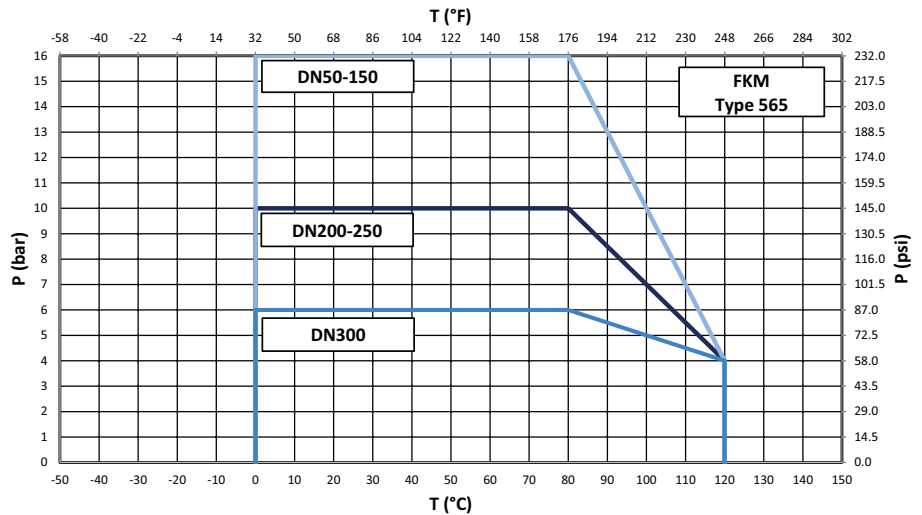

*Based on a lifetime of 25 years and water or similar media.

Specifications

Body type	565W - Wafer-style housing 565L - Lug-style housing					
Dimensions	d63/DN50 – d315/DN300, 2" – 12"					
Pressure ratings	Manual actuated		Electric actuated		Pneumatic actuated	
	DN50-150	PN16	DN50-200	PN10	DN50-250	PN10
	DN200-250	PN10	DN250	PN6	DN300	PN6
	DN300	PN6	DN300	PN4		
Actuation variants	Manually operated (lockable hand lever or manual reduction gear) Pneumatic actuated: FC, FO, DA Electric actuated: EA45-250 AC: 100 – 230 V, AC/DC: 24 V, Smart actuator dEA					
Actuator interface	EN ISO 5211					
Flange standards	ISO 7005 PN10/16, EN 1092 PN10/16, DIN 2501 PN10/16, ANSI/ASME B 16.5 Class 150, BS 1560: 1989 Class 125/150; BS 4504 PN10/16, JIS B 2220 10K, JIS B 2239 10K					
Markings	CE, UKCA					
Product Standard	EN ISO 16136					
Test Standard	ISO 9393-2, EN 12266-1 (leakage rate A)					
Approvals	ACS, ABS, BV, DNV, EAC, EPD, FDA, KTW-BWGL, LR, NSF; PZH, RINA, WRAS, SIL					



Sustainably future-proof

Ensuring the safe and reliable flow of fluids

What is more sustainable – thermoplastics or metal?
GF Piping Systems set out to answer this question and
commissioned a study of its Butterfly Valve 565 by an
independent institute.



The Swiss Climate AG analyzed the environmental impact as part of a Life Cycle Assessment (LCA) that served two main purposes:

The first purpose of the LCA was to achieve an EPD in accordance with EN 15804:2012+A2:2019. The Environmental Product Declaration (EPD) is a Type III environmental declaration that uses scientifically quantified data from the Life Cycle Assessment for the estimation of environmental impacts and comparisons between similar products. The Butterfly Valve 565 is the first industrial butterfly valve to obtain this certification and therefore enables customers to make an informed decision based on an analysis from a trusted and independent source.

The second purpose of the study was to conduct an analysis of the environmental impacts of the Butterfly Valve 565 and a metal alternative as part of a comparative LCA study in accordance with ISO 14040/44.

When comparing the valves' respective service lives, the Butterfly Valve 565 emits 26% less carbon emissions than the metal alternative.

Download the whitepaper to find all the results.



Reliable operation for demanding environments

The Butterfly Valve 565 has seen use in swimming pools, portable water treatment, and production, hot and cold-water plants, as well as refrigeration and HVAC installations. However, butterfly valves also play an important role in the maritime sector, as ships rely on extensive and lightweight piping systems for everything from potable water and wastewater to ballast water treatment.



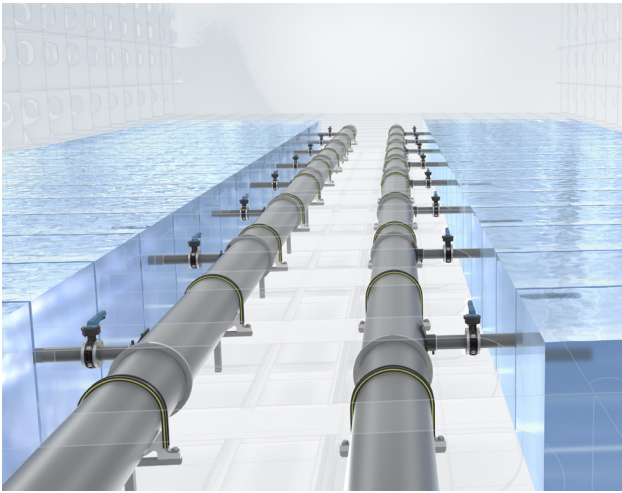

Ballast water treatment

Ballast water systems ensure safe operating conditions during voyages, help ships reduce stresses on the vessel's hull, and provide transverse stability. GF Piping Systems' maintenance-free solutions help to efficiently load, distribute, and unload ballast water from 0°C to 40°C, ensuring the ship can efficiently maneuver.

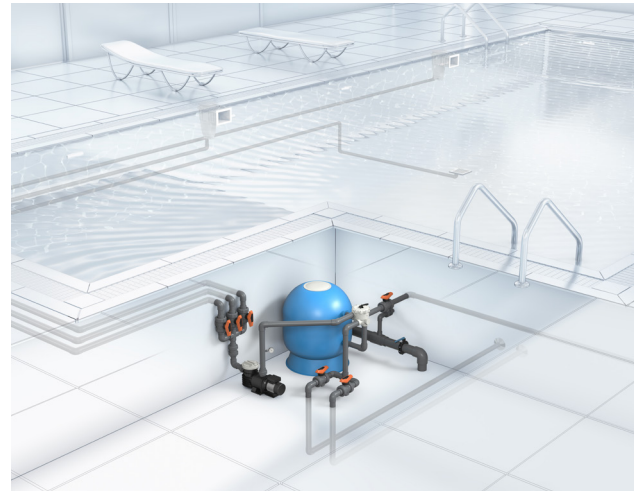

Aqua Parks & Swimming Pools

The superior materials of the Butterfly Valve 565 ensure high chemical and corrosion resistance, which leads to a long-lasting operation. Additionally, the lightweight and compact valve facilitates operation in confined spaces. Actuation possibilities such as pneumatic actuators and digital accessories ensure reliable and cost-effective operation.



Cooling

Corrosion and condensation-free materials are of utmost importance for reliable and efficient piping systems in cooling applications. Butterfly valves are used to control media flow within pipes. The simple design and short installation length make the Butterfly Valve 565 Lug-Style the ideal valve for cooling applications.

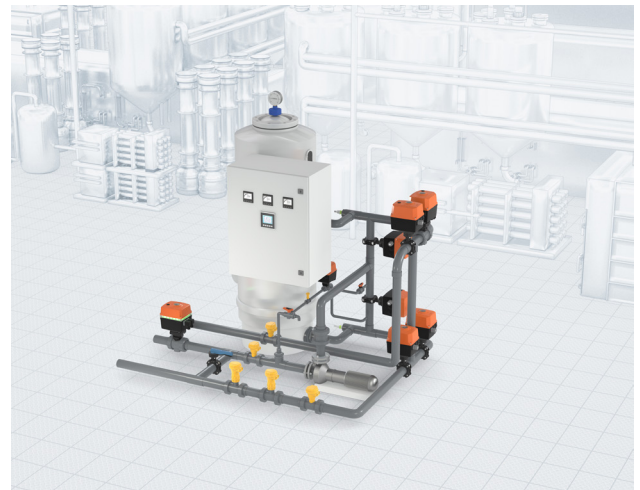

Media filtration

This technology is often used to harvest drinking and process water from surface and seawater. Due to the need for several flow processes, filters are made of numerous valves and bypass actuators. Decentralized membrane filtration systems can supply safe drinking water in low-income countries. GF Piping Systems offers maximum security and profitability for efficient processes, by eliminating maintenance costs caused by rust and deposits.



Learn more about
our reference cases.

Butterfly Valve 565 Wafer-Style

Beats metal in every round

Butterfly valves are ideal for controlling media flow in applications where compact design is crucial. Wafer-style butterfly valves can easily be mounted between two pipes using flange connections.





The Wafer-Style gives the full flexibility for the different installations types. The corrosion-resistant Butterfly Valve 565 comes in the same installation length as its metal counterparts (EN558/ISO5752 short). Therefore, the 565 is just as well suited for replacing old metal valves in existing piping systems as it is for new installations. The outstanding pressure and temperature performance allow the valve to be used in varied applications. Additionally, the superior characteristics of thermoplastic increase the possible installations even further and expand the lifetime compared to metal valves. Thus making the thermoplastic valve more cost-effective, too.

Introduced in 2021, the thermoplastic Butterfly Valve 565 has proven multiple times to be a reliable and durable solution for water and water treatment applications in the marine and water treatment industry, cooling applications and many more.

Together as one

Process Automation

We are a global leader in valves and actuation, liquid analysis, and flow solutions for water and wet chemicals applications.

For over 50 years, we have been going forward with our customers, helping them with sustainable innovations for applications in the water treatment and chemical process industries. With our solutions, we help solve water scarcity, overcome the challenge of aging infrastructure, and embrace the current opportunities with digitalization.

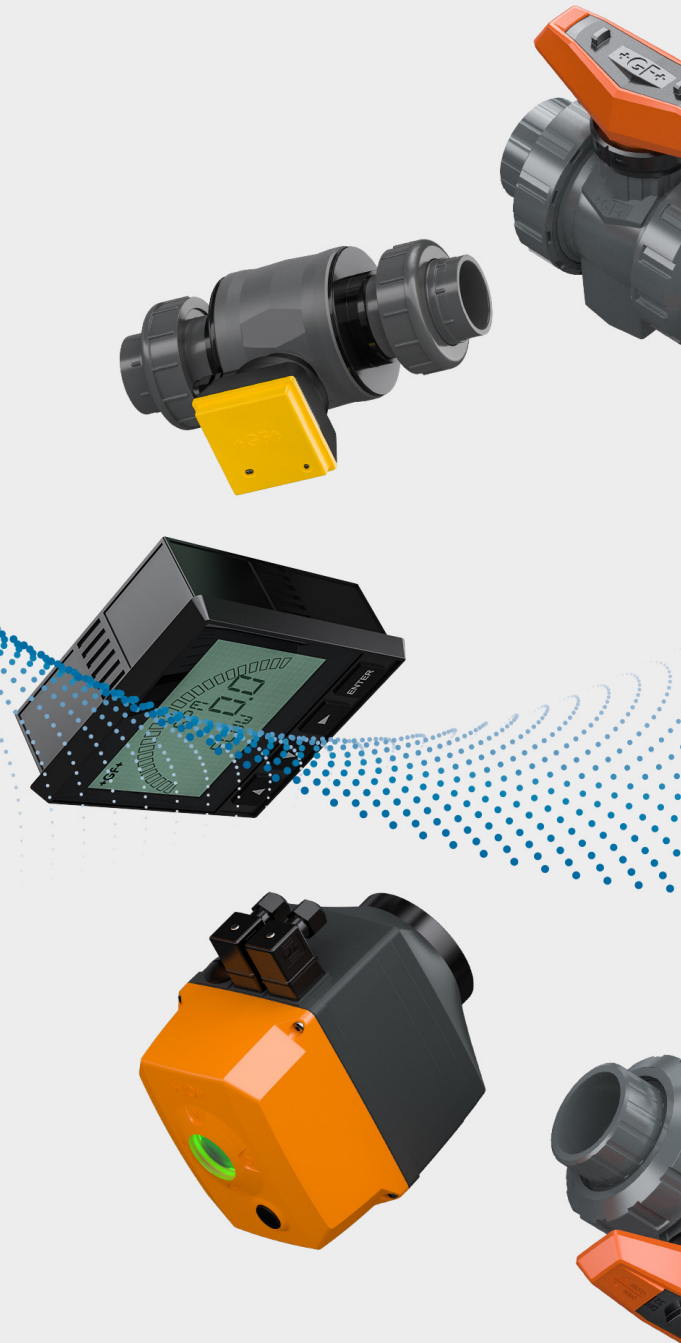

We use our knowhow and experience of the complete control loop to solve the entire process challenge. Enabling the design, selection and installation of Process Automation systems. With Process Automation, GF Piping Systems can supply every customer not just with highest quality parts but with an interoperable all-in-one solution.



One user experience across the whole control loop

GF Piping Systems is your experienced partner with a full portfolio of measurement, control, and actuation components, which are easy to install and use and have local support through all project phases. We offer the full package with our products and solutions, providing top-quality installation, a highly skilled team of experts standing by our customers' side every step of the way worldwide, and digitalized services ensuring a project is at the forefront of the market.



Design (Planning phase)

Easy planning thanks to application-specific solutions making an effortless combination around the complete control loop.



Select (Ordering phase)

Easy to select and order via configurators and matching components throughout the whole portfolio.



Install (Building phase)

Easy planning thanks to application-specific solutions making an effortless combination around the complete control loop.



Own (Operation phase)

Easy monitoring once installed, including spare part availability. Long lifetime and low maintenance make for low downtimes.

www.gfps.com/processautomation

Specification to operation

With Specialized Solutions, the global leader GF Piping Systems provides project support every step of the way to achieve construction excellence. Allowing owners and planners to concentrate on their daily business without interruption.

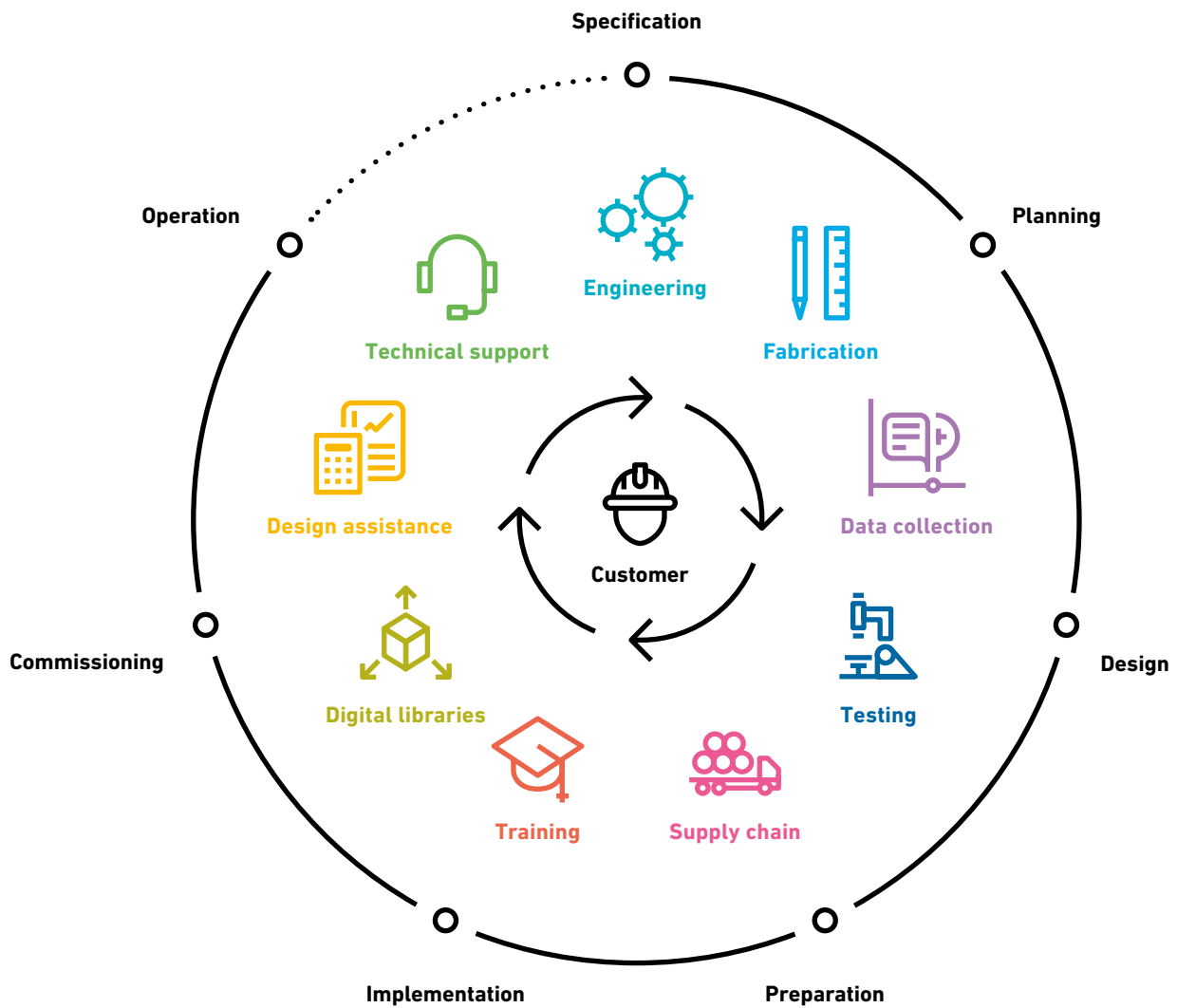



Engineering

Increase the efficiency of your project with the tailor made analysis packages from GF Piping Systems and decide which offer is right for you according to your needs. You have the choice between Project Analysis and Advanced Engineering, thus always receiving the appropriate support in every phase of your project.



Digital libraries

GF Piping Systems is continuously developing digital libraries with all of our product design drawings. Our files are fully compatible with Autodesk Revit, AVEVA, Intergraph, Autodesk AutoCAD Plant 3D and Trimble SketchUp with 3Skeng to provide proper engineering design tools used by planners, architects, owners and operators for BIM and Plant Design.

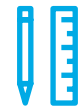

Custom product design and prefabrication

Having your individual needs and application in focus, our customizing teams forge the solution that fits you best, developing custom-made parts to complete systems or special solutions produced in small series, individual consulting and off-site prefabrication. Through our global network of flexible locations, we offer a wide range of comprehensive solutions.



Training

GF Piping Systems instructional courses to help you teach your customers and their installers essential knowledge for the welding of pipes and piping components, as well as an in-depth understanding of butt and electrofusion connections. Trainings are available virtually, in-house or on site. Trusted training, empowering you.



Ultrasonic Non-Destructive Testing (NDT)

When installing a system, the most critical parts are going to be the weldings – often seen as the weakest point of a system and highly critical to a safe and reliable operation. With Ultrasonic NDT, you can proceed with assurance thanks to scientific proof that the welds are secure.

www.gfps.com/specialized-solutions

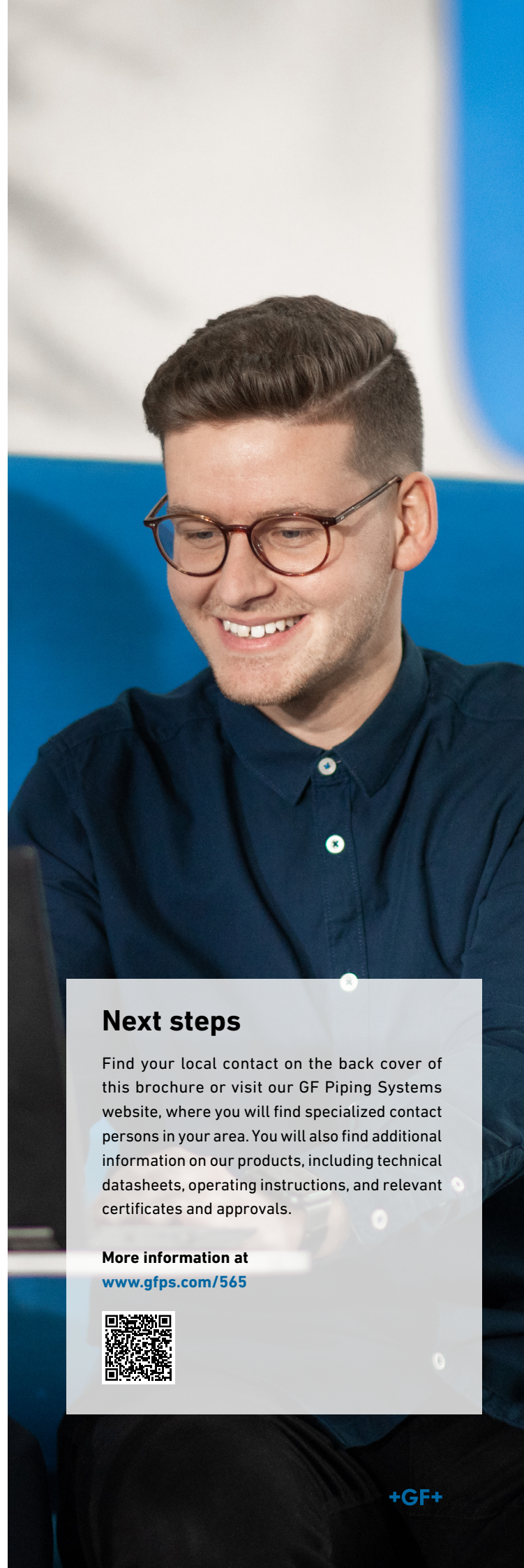

Next steps

Find your local contact on the back cover of this brochure or visit our GF Piping Systems website, where you will find specialized contact persons in your area. You will also find additional information on our products, including technical datasheets, operating instructions, and relevant certificates and approvals.

More information at

www.gfps.com/565



Local support around the world

Visit our webpage to get in touch with your local specialist:

www.gfps.com/our-locations



The information and technical data (altogether "Data") herein are not binding, unless explicitly confirmed in writing.
The Data neither constitutes any expressed, implied or warranted characteristics, nor guaranteed properties or a guaranteed durability. All Data is subject to modification. The General Terms and Conditions of Sale of Georg Fischer Piping Systems apply.