

Our System Solution

# Overview Butterfly Valves



## Benefits

# Butterfly Valves From GF – Right Choice

The wide range of innovative valves and continual developments in modularity and multifunctionality accentuate GF Piping Systems' role as a leading system supplier. The versatile butterfly valves feature not only great flexibility in how they can be used but also a high level of quality and durability. Aligned with the individual requirements of our customers, the valves are reliable, efficient and economical in use, thus providing you with sustainable added value.

### Longer life means higher profitability

The butterfly valves are based on a double eccentric operating principle, in which the disk does not touch the seal in the open position. This double eccentricity guarantees a longer lifetime of the system while at the same time reducing maintenance costs.

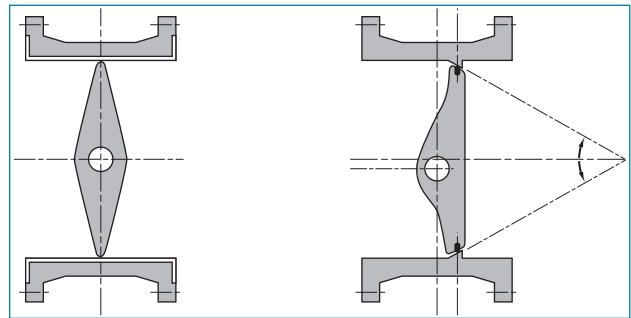

### Easy and quick

The new generation of butterfly valves has several convincing features, compared to earlier valve designs, such as an actuation torque that is up to 50 % lower when changing from the open to closed position. The advantage of minimal force and maximum efficiency not only makes the valve easier to operate, but also allows using smaller and more economical actuators.



### Optimal corrosion resistance

Due to the high performance plastics implemented in these valves, excellent resistance to corrosion is guaranteed. Maximum corrosion resistance reduces maintenance and repair costs and more importantly ensures longterm and safe use in transporting aggressive media in demanding industries such as the chemicals industry.



### Universal application options

The application oriented selection of diverse materials for housing and seals, the choice of manual, pneumatic and electric actuators as well as all the possible dimensions ranging from DN50 to DN600 render the universal character of the valve system. Combined with the modularity of the individual components, the system offers maximum versatility and freedom of choice.



## Features

# Top-quality Technology Compelling in Design and Functionality

What is impressive about the modular design of the system components is the first-rate functionality in every detail. Specified material properties and the innovative technical design provide the highest level of safety and quality in the application. Depending on the configuration of the butterfly valve characteristic product features and functionalities can be selectively combined: from the choice of manual, electric or pneumatic actuator to diverse flow and sealing components as well as electrical feedback systems and integration of individual regulating and control elements.

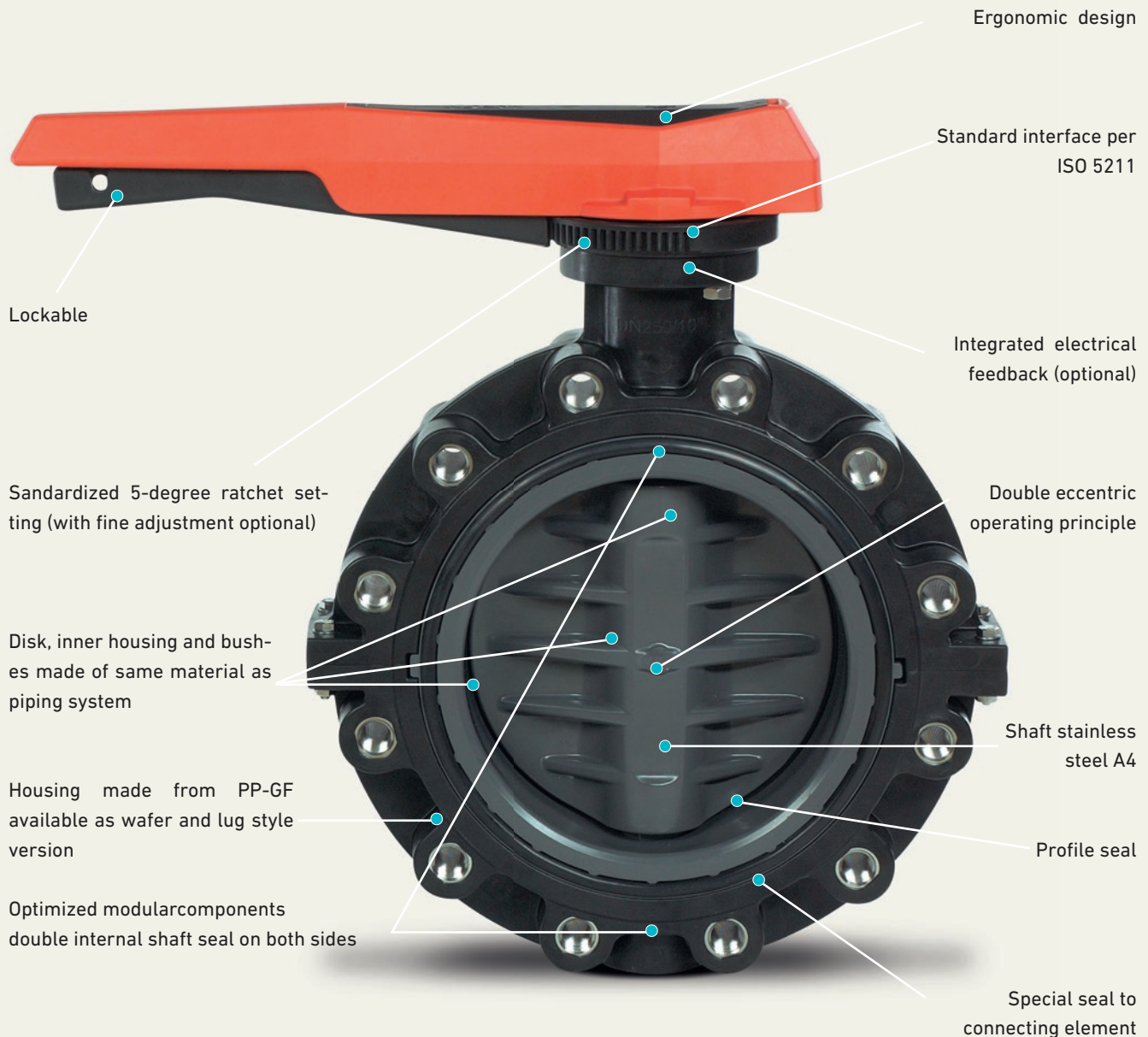

At a glance

# Build on High Performance and Versatility

When GF Piping Systems developed the various butterfly valves and their individual system components, the customary claim to a high level of quality and innovation were in the foreground, but highest priority was given to customer focus. The custommade approach and individual character of the system solutions, targeted to the specific requirements and application environments of customers, grant maximum flexibility, in addition to decisive added value. By focusing on the users in the planning, consulting and implementation phases, GF Piping Systems convinces their customers not only with their competence and expertise, but also with their indepth knowledge of the market and industry, based on extensive experience.

## Systematic quality

The numerous certifications according to customary standards and international standards as well as approvals for various applications are evidence to the high quality, safety and reliability of the system product range.

### Standards:

- DIN / EN / ISO / BS / ASTM / JIS (only wafer-style) / ANSI

### Approvals:

- DIBt / ACS / TA Luft / KTW / W270 / FDA / NSF61 and more  
Actuator interface according to DIN EN ISO 5211

## Modular product range

A wide selection of different materials and dimensions allows configuring your system to the particular application and medium. A versatile system that provides an ideal solution for every application.

## In every detail

The quality of a butterfly valve is largely determined by the quality of the individual components. Dedicated system parts, such as O-rings with PTFE content, offer the best possible functionality and operational reliability in applications with diverse environments and various media.



Standard wafer-style valve  
Type 567

Standard lug-style valve Type 578

Butterfly valve with fine  
adjustment

Butterfly valve with manual  
reduction gear

At a glance

# Unlimited Modularity for Maximum Flexibility and Precision

The comprehensive and application-oriented system solutions from GF Piping Systems offer ultimate modularity and complement on another ideally in terms of functionality. A large selection of standardized, high-quality components and actuating elements provide technical precision with maximum variability. The targeted combination or, if required, the fast and simple exchange of individual system components means there are no limits to versatility and flexibility. With smart solutions for actuation and control valves, such as positioners and integrated mechanical or electrical position feedback units for precise process control, the high demands of your industry are met.

## Process under control

The integrated electrical feedback function in the mounting flange constantly maintains an overview of the system and which valves are open or closed. The feedback concept includes a choice of five different types of end position switches. In addition, the type of actuator, electric or pneumatic, gives you a unique level of flexibility in configuring and operating your system.

## Variable control media

The variety of system components on offer enables integrating diverse controllers as required by your specific application. From simple open/close valves to precision flow control devices (controlled via PLC or other computer-aided instruments).

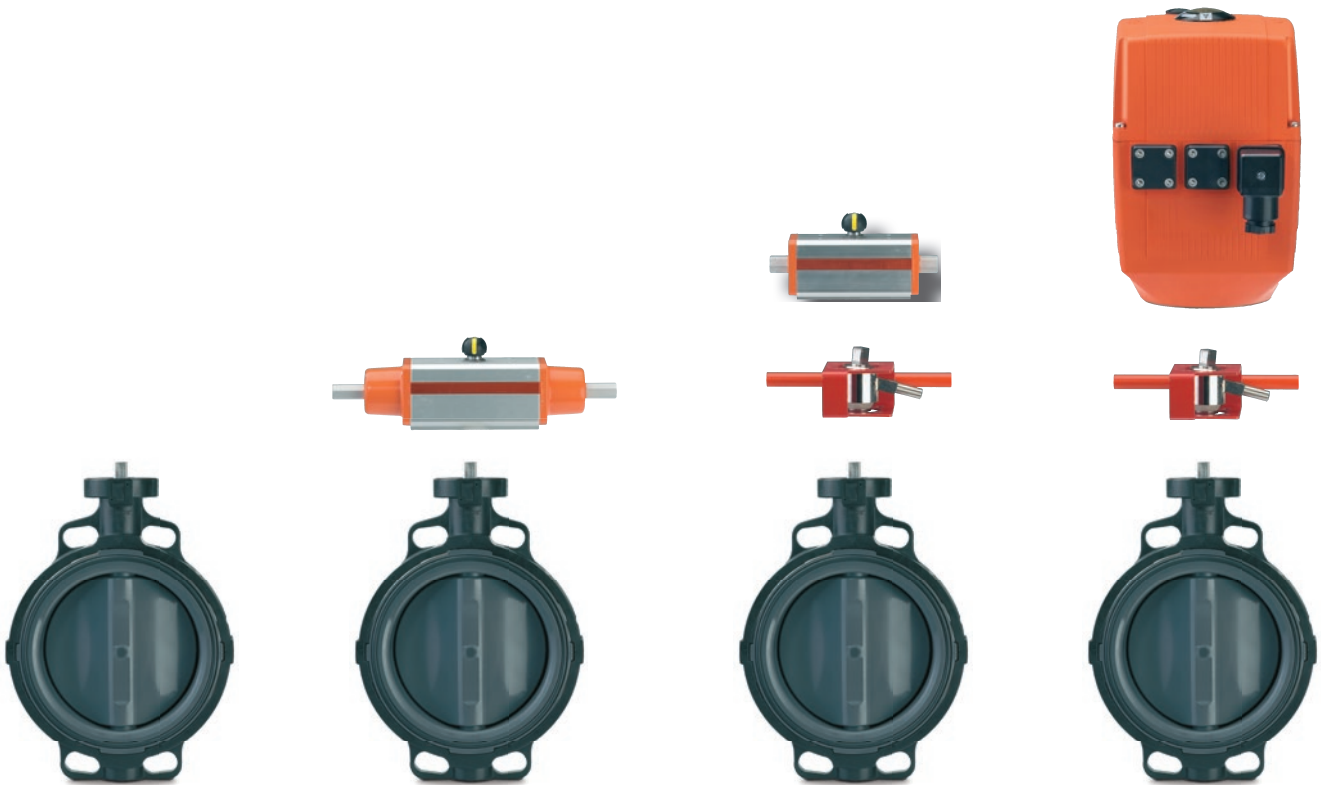

Standard wafer-style valve  
Type 567

Butterfly valve with pneumatic  
actuator – single acting

Butterfly valve with pneumatic  
actuator – double acting; optional  
manual override

Butterfly valve with electric  
actuator; optional manual override  
and electrical feedback

## Technical specifications

# More Than the Sum of Its Details

Taken together, innovative technologies, sophisticated materials processing and specifically implemented functionalities all contribute to the added value, on which our customers rely worldwide. Proven concepts are just as important as newly developed operating principles and individual components. The successful interaction of materials and technical elements leads to the high and dependable efficiency of these valves.

## + Torque movement (reference value) to open / close

(Standard valve, new condition)

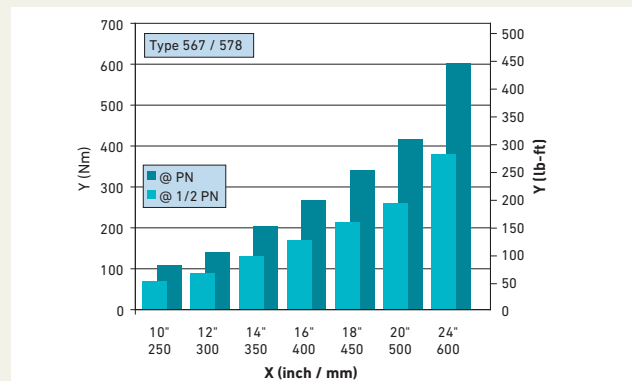
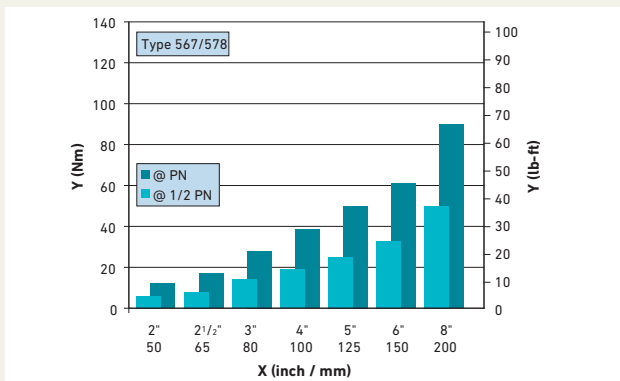

X nominal diameter DN (inch, mm)  
Y torque (Nm, lb-ft)

## Pressure-temperature diagram ABS, PVC-U, PVC-C

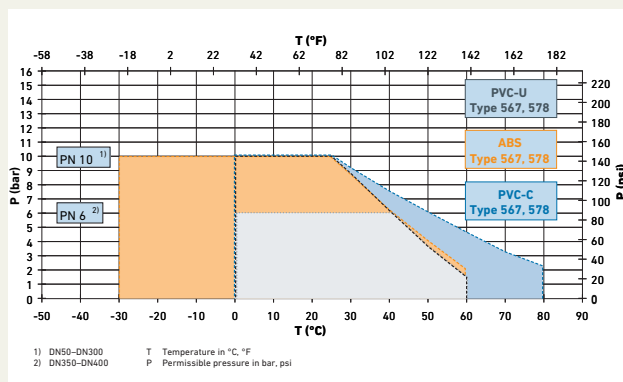

1) DN50–DN300  
2) DN350–DN400  
T Temperature in °C, °F  
P Permissible pressure in bar, psi

## Pressure-temperature diagram PP-H, PVDF

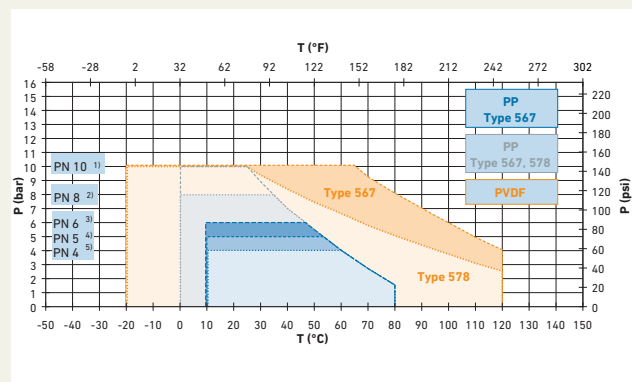

1) DN50–DN200  
2) DN250–DN300  
3) DN350–DN400  
4) DN450  
5) DN500–DN600  
T Temperature in °C, °F  
P Permissible pressure in bar, psi

## Material

# A System Environment of Diversity

The range of butterfly valves from GF Piping Systems with its modular element structure combines the aspects of standardization with those of specialization. This allows serving not only classic application areas, in which universal material and product characteristics are required, but also, highly demanding applications, e.g. for aggressive environments in the chemical process industry. Our customers benefit from the same high level of performance regarding quality and service – whether for standard applications or for special solutions, i.e. customization.



### Safety derived from operational excellence

The unique combination of the high-performance plastics PVDF (polyvinylidene fluoride) and PTFE (polytetrafluoroethylene) offers the maximum level of process and operational reliability that is so often required, especially in the chemical industry. The resistance to aggressive media, such as acids, saline solutions and hydrocarbons, derived from the integration of the PTFE profile passage seal is particularly effective. Equally impressive is the temperature resistance in the range of -20 °C to +120 °C, achieved through the specific combination and scope of materials. The PTFE seal is also available for PP-H and PVC-C butterfly valves.

### Low permeability

The PTFE butterfly valves afford a permeability far below average and thus utmost reliability, even when transporting diffusing substances. The mandatory 100 % leakproof and functional tests performed on the valves are testimony to the high quality.

### Lightweight champions

Enhancing the product range to include the large dimensions DN350 to DN600 enables the universal use of these butterfly valves, wherever large amounts of liquid media need to be safely transported. These special constructions for applications in water treatment or in the chemical industry are convincing because of their very high operational reliability and their nearly 50 % lower weight compared to butterfly valves made of metal. Customers profit from significant savings in time and costs for transport, storage and installation.

### Professional support worldwide

International teams of experts from GF Piping Systems resolutely carry on the customer-oriented approach, so successful in the product environment, in providing services to our customers. With individual technical advice and support in selecting materials, they are competent and experienced partners for our customers.

## Technical data

# Oriented to Your Individual Needs

The plastic butterfly valves from GF Piping Systems come in many variations and combine the unique nature of the material in design, application and performance. Characteristics, such as the much lower net weight, corrosion resistance and excellent chemical resistance, ensure maximum efficiency and reliability as well as a consistently high degree of economic efficiency over the entire lifetime of the product or the respective system.

## Technical Data

### Butterfly valves

	Designation	Manual		Pneumatic	Electric
<b>General</b>	Type	567	578	240 / 243 / 244	140 / 143 / 144
	Basis type			567 / 578	567 / 578
	Actuator type			PA30-70	EA31 / 42
	Dimension	DN50-DN600	DN50-DN300	DN50-DN600	DN50-DN600
	Pressure rating	PN4-PN10	PN10	PN4-PN10	PN4-PN10
	<b>Materials</b>	PVC-U	✓	✓	✓
PVC-C		✓	✓	✓	✓
ABS		✓	✓	✓	✓
PP-H		✓	✓	✓	✓
PVDF		✓	✓	✓	✓
<b>Connection</b>	Wafer	✓		✓	✓
	Lug		✓	✓	✓
	Threaded socket				✓
<b>Seal materials</b>	EPDM	✓	✓	✓	✓
	PTFE / FPM	✓	✓	✓	✓
	FPM	✓	✓	✓	✓
	Other	✓	✓	✓	✓
<b>Drive</b>	Manual	✓	✓		
	Pneumatic actuation			✓	
	Electric actuation				✓
	With manual gear	✓	✓		



## Technical data

# Strength through Diversity

The metal valves are a valuable complement to the line of plastic butterfly valves and they contribute decisively to the versatility of the overall system. Added value is especially generated by the permanently high temperature and pressure resistance, the low pressure loss and long lifetime. The resulting cost and performance efficiency, together with the compact construction for safe and easy handling, firmly establish the metal butterfly valves in the modular system world of GF Piping Systems.



## Metal valves

### Technical features

<b>Dimension</b>	Type 038 Type 039	
<b>Pressure rating</b>	Type 039 / Type 038	PN16
<b>Installation length</b>	DN50 - DN500 DN600 - 1200	EN 558 series 20 ISO 5752 series 20 Own standard
<b>Flange connection measurements</b>		EN1092-1 PN10 / PN16 DIN 2501 PN10 / PN16 ANSI B 16.5, Class 150
<b>Mounting flange</b>		EN ISO 5211
<b>Leakproof test</b>		ISO 5208-93 (DIN3230)
<b>Allowable working pressure</b>		max. 10 bar / 16 bar
<b>Allowable differential pressure</b>		max. 10 bar / 16 bar
<b>Use in vacuum</b>		up to 0.2 bar absolute (higher vacuum depending on medium and temperature)
<b>Material specifications of housing</b>	Type 038 / Type 039	Ductile cast iron ASTM norm: A395 M:88 DIN / EN NORM EN JS 1020 EN 1563 Coating: DN50 - DN300 Rilsan, from DN 350 Epoxy
<b>Disk</b>		Ductile cast iron ASTM norm: A395 M:88; DIN / EN NORM EN JS 1020 EN 1563 up to DN300 Rilsan-coated, from DN350 Epoxy-coated Stainless steel ASTM norm: A351-94 CF8M; DIN / EN NORM 1.4408 EN 10213-4 Aluminum bronze: ASTM norm: B 148-92 C95800 DIN / EN NORM: EN 1982-99 CC333G
<b>Seal liner</b>		EPDM, FPM, other materials available on request (depending on pressure, medium and material)
<b>Temperature range</b>	-10°C to +180° C up to +80 °C	with disk with coating



Application areas

# Your Processes Determine the System – Our Products Ensure the Necessary Safety and Efficiency

The many demanding application areas and media in use today necessitate a consistently high level of safety, efficiency, quality and profitability of systems as well as of the individual components. GF Piping Systems has successfully developed application-oriented system solutions for discerning customers for over 50 years. As different as our customers, their process environments and requirements are, as diverse and individual are our specific products. Focused on customer and industry-specific circumstances, we offer a multitude of systems, and valves as well. These are ideally integrated in the process structure of complete system and uncompromisingly meet the challenge of high performance and quality requirements.

## Chemical process industry

Because of the aggressive environment of many applications in the chemical industry, production and transport processes in this segment pose a particular challenge to piping systems regarding safety and quality. When dosing, mixing and batching chemicals good flow and linear control characteristics are basic requirements for efficient and safe processes. Contamination must be prevented in all process steps, especially surface treatment. Integrating the right system components is therefore crucial. Designed specifically for the requirements and stringent regulations in this demanding market, the butterfly valves from GF Piping Systems provide high flow performance and precise process control and regulation.

## Microelectronics

The majority of all processes in microelectronics take place under strictly controlled cleanroom conditions. Particularly high demands are placed on the consistent purity of the process water as well as the transport of ultrapure water within the manufacturing process. The new generation of butterfly valves is ideally suited for this challenging environment and also greatly improves hygiene in the application environment thanks to minimal dead space. A consistent thermal expansion behavior at the same time increases safety and consequently reduces the need for costly maintenance.

# A Modern System with Universal Character



The universal system and material properties of this product range are impressive, making it possible to realize numerous applications in the chemical process industry, microelectronics and water treatment. Profitability is achieved through system benefits, i.e. the use of plastics as system material. Not only the excellent abrasion and corrosion resistance to external influences and aggressive media, as proved in a direct comparison with metal, but also the smooth surface and low weight ensure added value in terms of system lifetime, maintenance and handling. The „Total Plastic Solutions“ from GF Piping Systems are therefore a guarantee for safety and quality, but also efficiency and profitability in nearly all applications.

## Water treatment

Economical and sustainable water treatment is becoming more and more important, especially in light of the increasing scarcity of resources. Thanks to their technical features and functionalities, the versatile butterfly valves from GF Piping Systems meet this global need. In water treatment applications they are mainly implemented to transport the water. Depending on the chemical composition of the medium, the use of different types of butterfly valves is possible. For example, type 567 is generally preferred for its low weight, corrosion resistance and low tightening torque. A viable alternative to the plastic valves would be the metal butterfly valve type 039. This valve has been designed for demanding applications with a pressure rating of up to PN16 and because of its high stability offers added value in terms of resistance and durability.

## Energy

With smart and comprehensive plastic solutions, GF Piping Systems actively contributes to the successful realization of complex, highly specialized water and chemical applications in the energy production of today and tomorrow. Selecting ideal components in the right material and implementing them efficiently are decisive for successful processes as well as the entire system. GF Piping Systems offers solutions targeted for safety and reliability and feature such outstanding properties, such as high performance, low weight, reduced energy consumption, excellent corrosion resistance and minimal downtime. The innovative design, flow efficiency and control characteristics, for which the butterfly valves are known, are especially appreciated in cooling applications in energy production.

# Worldwide at home

Our sales companies and representatives ensure local customer support in over 100 countries

[www.gfps.com](http://www.gfps.com)

## Argentina / Southern South America

Georg Fischer Central Plastics Sudamérica S.R.L.  
Buenos Aires, Argentina  
Phone +54 11 4512 02 90  
[gfcentral.ps.ar@georgfischer.com](mailto:gfcentral.ps.ar@georgfischer.com)  
[www.gfps.com/ar](http://www.gfps.com/ar)

## Australia

Georg Fischer Pty Ltd  
Riverwood NSW 2210 Australia  
Phone +61 (0) 2 9502 8000  
[australia.ps@georgfischer.com](mailto:australia.ps@georgfischer.com)  
[www.gfps.com/au](http://www.gfps.com/au)

## Austria

Georg Fischer Rohrleitungssysteme GmbH  
3130 Herzogenburg  
Phone +43 (0) 2782 856 43-0  
[austria.ps@georgfischer.com](mailto:austria.ps@georgfischer.com)  
[www.gfps.com/at](http://www.gfps.com/at)

## Belgium / Luxembourg

Georg Fischer NV/SA  
1070 Bruxelles/Brüssel  
Phone +32 (0) 2 556 40 20  
[be.ps@georgfischer.com](mailto:be.ps@georgfischer.com)  
[www.gfps.com/be](http://www.gfps.com/be)

## Brazil

Georg Fischer Sist. de Tub. Ltda.  
04571-020 São Paulo/SP  
Phone +55 (0) 11 5525 1311  
[br.ps@georgfischer.com](mailto:br.ps@georgfischer.com)  
[www.gfps.com/br](http://www.gfps.com/br)

## Canada

Georg Fischer Piping Systems Ltd  
Mississauga, ON L5T 2B2  
Phone +1 (905) 670 8005  
Fax +1 (905) 670 8513  
[ca.ps@georgfischer.com](mailto:ca.ps@georgfischer.com)  
[www.gfps.com/ca](http://www.gfps.com/ca)

## China

Georg Fischer Piping Systems Ltd  
Shanghai 201319  
Phone +86 21 3899 3899  
[china.ps@georgfischer.com](mailto:china.ps@georgfischer.com)  
[www.gfps.com/cn](http://www.gfps.com/cn)

## Denmark / Iceland

Georg Fischer A/S  
2630 Taastrup  
Phone +45 (0) 70 22 19 75  
[info.dk.ps@georgfischer.com](mailto:info.dk.ps@georgfischer.com)  
[www.gfps.com/dk](http://www.gfps.com/dk)

## Finland

Georg Fischer AB  
01510 VANTAA  
Phone +358 (0) 9 586 58 25  
Fax +358 (0) 9 586 58 29  
[info.fi.ps@georgfischer.com](mailto:info.fi.ps@georgfischer.com)  
[www.gfps.com/fi](http://www.gfps.com/fi)

## France

Georg Fischer SAS  
95932 Roissy Charles de Gaulle Cedex  
Phone +33 (0) 1 41 84 68 84  
[fr.ps@georgfischer.com](mailto:fr.ps@georgfischer.com)  
[www.gfps.com/fr](http://www.gfps.com/fr)

## Germany

Georg Fischer GmbH  
73095 Albershausen  
Phone +49 (0) 7161 302 0  
[info.de.ps@georgfischer.com](mailto:info.de.ps@georgfischer.com)  
[www.gfps.com/de](http://www.gfps.com/de)

## India

Georg Fischer Piping Systems Pvt. Ltd  
400 083 Mumbai  
Phone +91 22 4007 2000  
Fax +91 22 4007 2020  
[branchoffice@georgfischer.com](mailto:branchoffice@georgfischer.com)  
[www.gfps.com/in](http://www.gfps.com/in)

## Indonesia

George Fischer Pte Ltd  
41371 Jawa Barat  
Phone +62 267 432 044  
Fax +62 267 431 857  
[indonesia.ps@georgfischer.com](mailto:indonesia.ps@georgfischer.com)  
[www.gfps.com/id](http://www.gfps.com/id)

## Italy

Georg Fischer S.p.A.  
20063 Cernusco S/N (MI)  
Phone +39 02 921 861  
[it.ps@georgfischer.com](mailto:it.ps@georgfischer.com)  
[www.gfps.com/it](http://www.gfps.com/it)

## Japan

Georg Fischer Ltd  
530-0003 Osaka  
Phone +81 (0) 6 6341 2451  
[jp.ps@georgfischer.com](mailto:jp.ps@georgfischer.com)  
[www.gfps.com/jp](http://www.gfps.com/jp)

## Korea

Georg Fischer Korea Co. Ltd  
Unit 2501, U-Tower  
120 HeungdeokJungang-ro  
(Yeongdeok-dong)  
Giheung-gu, Yongin-si, Gyeonggi-do  
Phone +82 31 8017 1450  
Fax +82 31 217 1454  
[kor.ps@georgfischer.com](mailto:kor.ps@georgfischer.com)  
[www.gfps.com/kr](http://www.gfps.com/kr)

## Malaysia

George Fischer (M) Sdn. Bhd.  
40460 Shah Alam, Selangor Darul Ehsan  
Phone +60 (0) 3 5122 5585  
Fax +60 (0) 3 5122 5575  
[my.ps@georgfischer.com](mailto:my.ps@georgfischer.com)  
[www.gfps.com/my](http://www.gfps.com/my)

## Mexico / Northern Latin America

Georg Fischer S.A. de C.V.  
Apodaca, Nuevo Leon  
CP66636 Mexico  
Phone +52 (81) 1340 8586  
Fax +52 (81) 1522 8906  
[mx.ps@georgfischer.com](mailto:mx.ps@georgfischer.com)  
[www.gfps.com/mx](http://www.gfps.com/mx)

## Middle East

Georg Fischer Piping Systems (Switzerland) Ltd  
Dubai, United Arab Emirates  
Phone +971 4 289 49 60  
[gcc.ps@georgfischer.com](mailto:gcc.ps@georgfischer.com)  
[www.gfps.com/int](http://www.gfps.com/int)

## Netherlands

Georg Fischer N.V.  
8161 PA Epe  
Phone +31 (0) 578 678 222  
[nl.ps@georgfischer.com](mailto:nl.ps@georgfischer.com)  
[www.gfps.com/nl](http://www.gfps.com/nl)

## Norway

Georg Fischer AS  
1351 Rud  
Phone +47 67 18 29 00  
[no.ps@georgfischer.com](mailto:no.ps@georgfischer.com)  
[www.gfps.com/no](http://www.gfps.com/no)

## Philippines

Georg Fischer Pte Ltd  
Representative Office  
Phone +632 571 2365  
Fax +632 571 2368  
[sgp.ps@georgfischer.com](mailto:sgp.ps@georgfischer.com)  
[www.gfps.com/sg](http://www.gfps.com/sg)

## Poland

Georg Fischer Sp. z o.o.  
05-090 Sekocin Nowy  
Phone +48 (0) 22 31 31 0 50  
[poland.ps@georgfischer.com](mailto:poland.ps@georgfischer.com)  
[www.gfps.com/pl](http://www.gfps.com/pl)

## Romania

Georg Fischer Piping Systems (Switzerland) Ltd  
020257 Bucharest - Sector 2  
Phone +40 (0) 21 230 53 80  
[ro.ps@georgfischer.com](mailto:ro.ps@georgfischer.com)  
[www.gfps.com/int](http://www.gfps.com/int)

## Russia

Georg Fischer Piping Systems (Switzerland) Ltd  
Moscow 125040  
Phone +7 495 748 11 44  
[ru.ps@georgfischer.com](mailto:ru.ps@georgfischer.com)  
[www.gfps.com/ru](http://www.gfps.com/ru)

## Singapore

Georg Fischer Pte Ltd  
11 Tampines Street 92, #04-01/07  
528 872 Singapore  
Phone +65 6747 0611  
Fax +65 6747 0577  
[sgp.ps@georgfischer.com](mailto:sgp.ps@georgfischer.com)  
[www.gfps.com/sg](http://www.gfps.com/sg)

## Spain / Portugal

Georg Fischer S.A.  
28046 Madrid  
Phone +34 (0) 91 781 98 90  
[es.ps@georgfischer.com](mailto:es.ps@georgfischer.com)  
[www.gfps.com/es](http://www.gfps.com/es)

## Sweden

Georg Fischer AB  
117 43 Stockholm  
Phone +46 (0) 8 506 775 00  
[info.se.ps@georgfischer.com](mailto:info.se.ps@georgfischer.com)  
[www.gfps.com/se](http://www.gfps.com/se)

## Switzerland

Georg Fischer Rohrleitungssysteme (Schweiz) AG  
8201 Schaffhausen  
Phone +41 (0) 52 631 3026  
[ch.ps@georgfischer.com](mailto:ch.ps@georgfischer.com)  
[www.gfps.com/ch](http://www.gfps.com/ch)

## Taiwan

Georg Fischer Co. Ltd  
San Chung Dist., New Taipei City  
Phone +886 2 8512 2822  
Fax +886 2 8512 2823  
[www.gfps.com/tw](http://www.gfps.com/tw)

## United Kingdom / Ireland

Georg Fischer Sales Limited  
Coventry, CV2 2ST  
Phone +44 (0) 2476 535 535  
[uk.ps@georgfischer.com](mailto:uk.ps@georgfischer.com)  
[www.gfps.com/uk](http://www.gfps.com/uk)

## USA / Caribbean

Georg Fischer LLC  
9271 Jeronimo Road  
92618 Irvine, CA  
Phone +1 714 731 8800  
Fax +1 714 731 6201  
[us.ps@georgfischer.com](mailto:us.ps@georgfischer.com)  
[www.gfps.com/us](http://www.gfps.com/us)

## International

Georg Fischer Piping Systems (Switzerland) Ltd  
8201 Schaffhausen/Switzerland  
Phone +41 (0) 52 631 3003  
Fax +41 (0) 52 631 2893  
[info.export@georgfischer.com](mailto:info.export@georgfischer.com)  
[www.gfps.com/int](http://www.gfps.com/int)

The technical data are not binding. They neither constitute expressly warranted characteristics nor guaranteed properties nor a guaranteed durability. They are subject to modification. Our General Terms of Sale apply.